

Case Study 1

Configuring E-Commerce Web Server

If a Web server that is separate from the e-commerce server is required, it will be configured in much the same way as the e-commerce web serve. The primary requirements will be an appropriate link to the Web store. An excellent example of how this type of server management is done can be found on the American Diabetes Association Web site. The primary Web site is at <http://www.diabetes.org>. The E-Commerce store is hosted at <http://merchant.diabetes.org>

Database Server

Typically you do not want the database server to be accessible to the outside world. It should sit behind a firewall and not be directly accessible to the Internet. In that case it will be accessible via the LAN environment behind the firewall. If the Web server and the database server are on the same machine, then the database is exposed to outside access. This has the potential of permitting access to private data such as credit cards, etc. While certainly; SQL Server does provide login access security and other means of locking down the database, making the database publicly inaccessible helps to ensure security.

Multiple Server Support

As mentioned, the simplest of Web sites would be one single web server with all functionality on that Web server (as shown in Fig 1) . The next level of division , as shown in Fig 2 , is to separate any Web server support from database support. This would require two servers in the data farm. The next challenge is when multiple Web servers and database servers are needed to support transaction volume as shown in Fig 3, while the fundamental coding and database functionality is the same, there are issues of data synchronization, content synchronization, load balancing , etc., that will need to be addressed. Specifically tackling those issues is beyond the scope of this Case study, but careful consideration should be given to these issues before launching a potential high transaction volume Web site to the public.



Figure 1 Single Server Farm

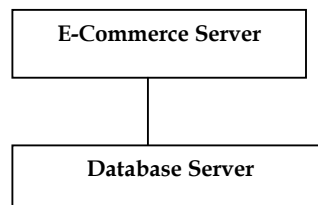

Figure 2 Multiple Server Farm

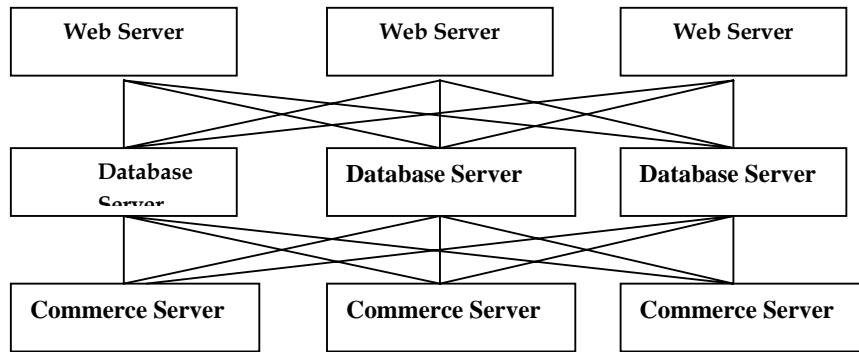

Figure 3 High Transaction Volume Server farm

It is also important to point out that as Web Sites grow and different levels of traffic spiking occur, the server farm configuration may change. Ensuring up front that the foundation development of the store is done properly for future growth is critical.

Staging and Development Server Management

While much of the attention is given to the production Web server farm, consideration should also be given to development server and staging server management. The development server is where ongoing development will take place for new functionality on the e-commerce web server.

The staging server will be utilized for staging Web site updates into the Web server farm to ensure all is working . This phase is especially critical if updates will be ongoing and frequent, especially in a multi-server production environment. If the updates to the site are significant, it may be critical to do proper load testing to ensure the changes will not fail under a full production load.

Server Management

Many of the traditional challenges of managing a client /server farm environment are also inherent in managing a web server farm. Key aspects of any good development and production management process include source code control, backups, etc. In this section we will review some of those requirements. Also, we will review the basics of setting up the web site so we can kick off our development .

Development Environment

Building an e-commerce store is not significantly different than building an internal client server application. Good development techniques and tools are critical.

Visual SourceSafe is an excellent tool for managing source code for a project. And, it does an excellent job of managing code checkin and checkout in a group project development environment. The SourceSafe database can reside on the development server, or preferably on a separate server on the network.

A development requirement unique to an electronic commerce web server development environment is that all of the source code files must be worked on in a central development server. Figure shows the basic development process for working in visual Interdev on the development web server.

The developer in this environment will connect to the web server via visual InterDev/. The FrontPage extensions will need to be installed on the web server for the IP address of the development web site, Interdev then connects via that IP address.

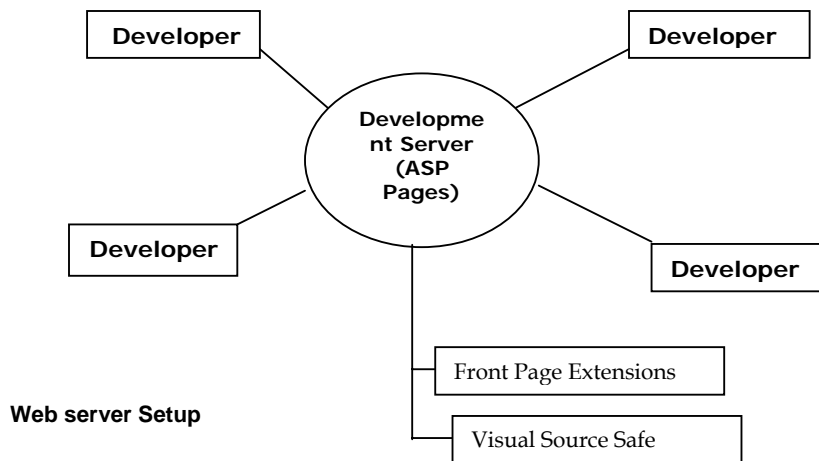

To create our development environment, let's go through the steps to configure internet information server and FrontPage Extensions, and then connect via visual InterDev.

1. First start up Internet Information Server. The Microsoft Management Console (MMC) is utilized for managing processes on the server. In this case the snap-ins are for configuring the internet services including FTP, Web, and SMTP. Figure shows the MMC.

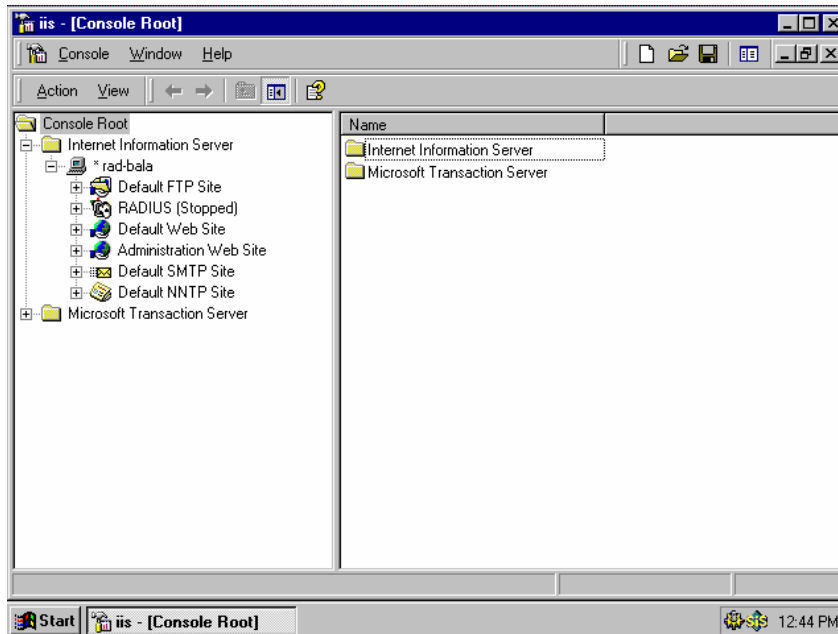

2. Our next task is to configure the web site. In the example in this book the web site is simply going to run off the default web site installed with IIS. You can create a new web site and apply and IP address to it . The following Fig shows the configuration panel for the web site. For a local web site on the machine use the localhost IP of 127.0.0.1

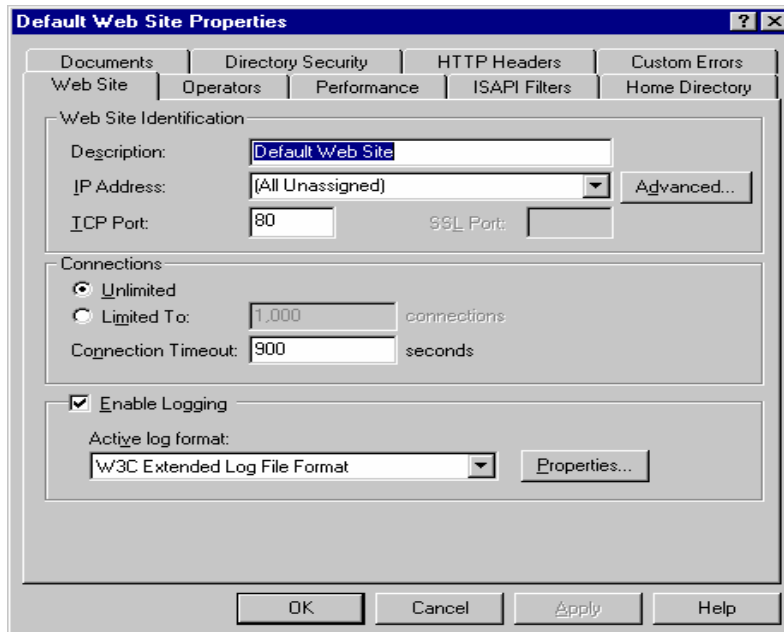

3. We also need to configure the home directory to ensure that we have the proper setting for our web site. The home directory pane is. The FrontPage web option must be checked to ensure the site supports FrontPage extension. The rest of the defaults should be fine.

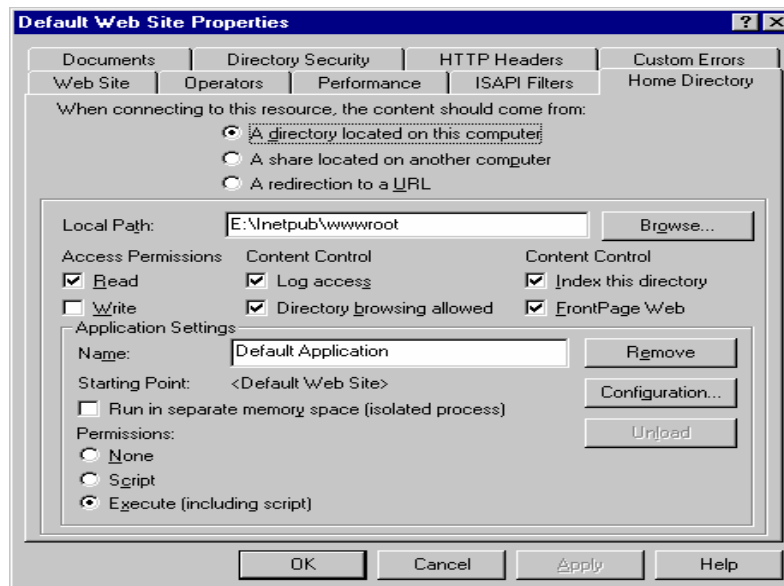

4. That gets the basics of our web site set up. Now we need to install the front page extensions on the site. Start up the front page server administrator, which is found in the windows NT 4 option Pack program group. From the list box select the new web site you have created. Then select install to create the extensions on the web server.
5. Now we are ready to connect to the web site in visual InterDev. To create our new project, select the new tab and visual Interdev project. Then give the project a name.

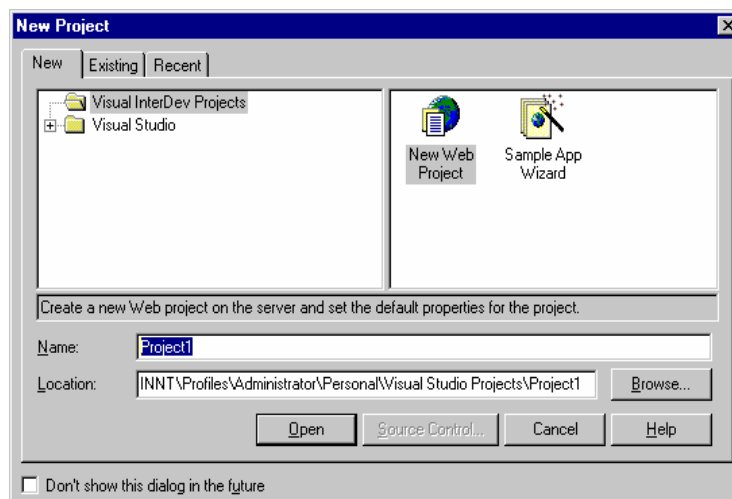

6. Visual InterDev will next prompt us for the IP address of the Web site we want to connect to. If it is the local site on the web server, then the IP is 127.0.0.1 or Localhost.

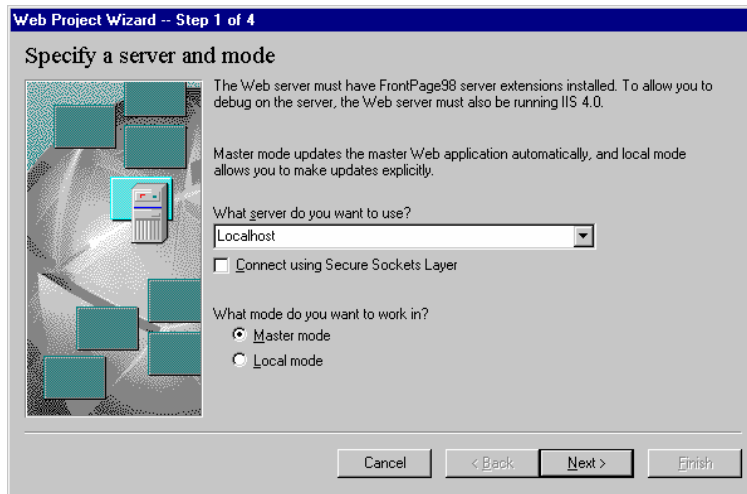

7. Once we have selected the web site we want to connect to, it will then ask what virtual web or web application we wish to connect to.
8. And with that, we are connected to our web site. When the new web application is created, a new global.asa file is created. The global.asa file will contain global settings for applications and session level actions for our web application. At this stage we are ready to begin developing our web site.

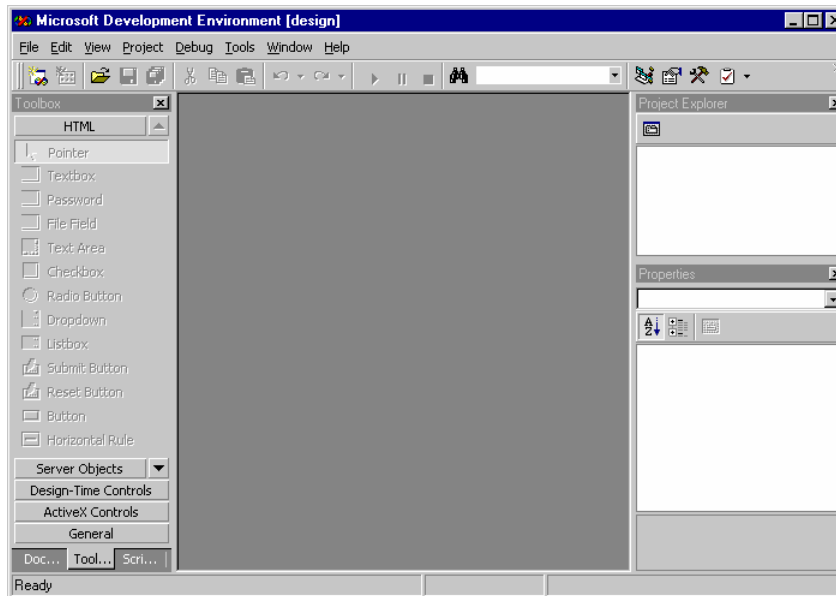

Server Backups

Backing up server data is our course critical. Perhaps on the web backups are even more crucial due to the transactional nature of the web site and the need to have 24x7x365 capability.

Requirement	Description
ASP and other key web files	Of course the code, images, HTML Pages And other files on the web site should be Backed up frequently, keeping backups Over time may be important as well in Case past content needs to be resurrected.
COM objects	Business objects we will be creating in Visual basic 6 will also need to be backed Up on a frequent basis. Of course, the Source code for these objects should be Backed up as well
SSL certificates	Often missed in the backup process is the Requirement to store the SSL certificates In a backed up location. If the certificate Are lost, there is no choice but to request A new set of certificates.
ODBC DSNs	Another oft-missed item is backing up the Setting of ODBC DSNs on the web Server. If you are using file DSNs, the Actual DSN can be backed up.
IIS configuration setting	If you are making changes to the default IIS configuration settings, those should Also be noted and saved in case the web Server needs to be rebuilt.
SQL server configuration Settings	The same goes for the SQL server Configuration settings as with the IIS With the IIS configuration settings
Operating system and other	As with any good standard backup and quick Server files recovery, the full system should be backed up frequently.

Security

As mentioned earlier, security is a key issue for configuring the web site. We can secure our web site directly at the web level in IIS. This is opposed to implementing database security and not allowing access to content via ASP coding.

Directory security pane of IIS for the web site. In general anonymous access is the setting for providing public access to a web site. If a particular virtual root or directory needs to be locked down further, you can implement basic authentication and windows NT challenge/Response. Basic authentication sends passwords across the internet in clear text. In windows NT challenge/response, you have to use internet

explorer to gain access to the web site. In either case, the user is prompted with a username and password dialog box.

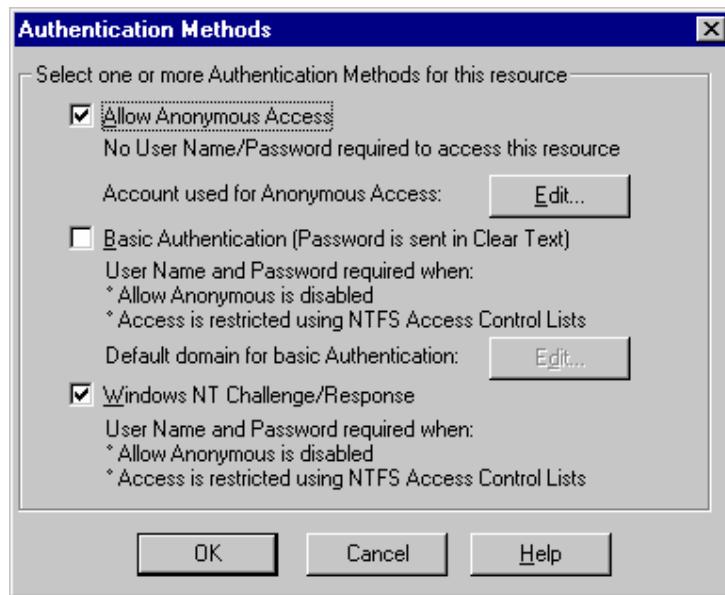

Also on the security front, management a of SSL certificates is also critical. On the primary management interface of the IIS management console is the key Manager icon. Clicking on that will bring up the key manager interface as shown in Fig.

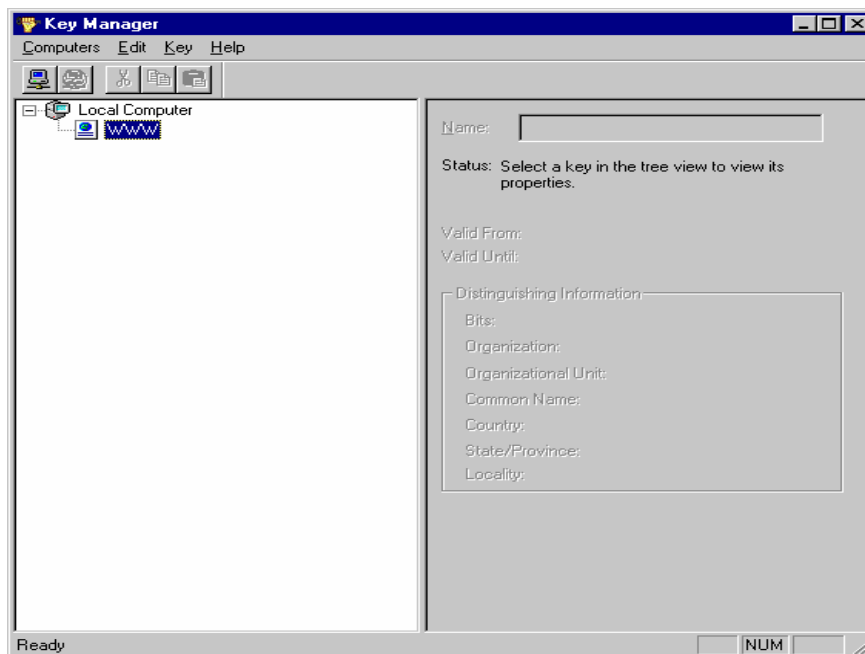

In the key manager you can create a new key, install certificates from a certificate authority import certificates, and back up certificates.

Database Setup

Configuring the database is as important as setting up the web server. While it is out of the scope of this book to go through all of the ins and outs of database configuration, here are a few items to consider.

Configuration	Description
Peak loading	Unlike the business environment where the pack speck load may be a moderate blip on the radar, web sites can often have peaks at unusual times that will require far more resources than day to day loading. Holidays, sales promotions, and other events can provide significant loading requirements. Ensure the web server can support extended connections and data objects. Each of these will impact the server configuration requirements etc.
Drive space	Transaction logs and other space requirements, including sheer data storage of information collected form the web, can impact drive storage requirements. Continuing to monitor the drive utilizations, etc is critical.
Multiple server support	If multiple database server are in place, Data, order, customer profiles, and other Issues must be addressed up front in the Basic system design.

Backup and replication is also a critical issue. There are several different scenarios that should be considered when building in redundancy and backup for the database server.

Configuration	Description
Device backup	Simple device backup with backup to tape nightly can provide basic backup capabilities. The only downside is that there is no real time backup to ensure the web site will stay up without significant down time.
Warm backup	There are possible warm backup scenarios where the database data is transferred or replicated on an infrequent basis(perhaps hourly or less). If the data base server should go down, a simple reconfiguration of ODBC setting to point at the warm backup will keep the web site up and functioning.
Real time replication	The best of all worlds is real time replication between database servers. Putting this kind of requirement on the database server calls for significant planning for resource loading, depending on the different transaction levels.

Another critical issue is supporting database development that ensures live site synchronization and updates go smoothly. Any time updates are made to the production database server from the development server, issues such as ensuring peak loading will not be affected and providing security become critical to the web site's success.

Load Planning

As illustrated throughout many of the discussion in this case study on system design, load planning is a critical issue. Coding of the e-commerce platform for core functionality may have a minimal impact, but if significant load is being planned for, ensuring the code is solid and is planned to handle multiple server requirements will be important.

There are excellent load planning tools to be found on the web. If you are working with an ISP to run and manage the server farm, the ISP will typically have load testing capabilities to assist in planning for different traffic loads. In these tests, it is important to ensure that key code heavy sections of the site are properly tested.

Browser Considerations

Finally, a key part of system planning is understanding the browser requirements that the system will need to support. While much of this relates to design, in some cases the type of browser may be dictated if certain parts of the site are coded to use extended browser feature(such as ActiveX or DHTML). An example of this could include a store manager that is developed to use a specific browser for extended functionality. In some cases internet explorer may be required for NT challenge Response. Or perhaps in rare cases internet explorer remote data services may be needed.

Summary

System design for a Web site is critical to ensuring success of all that hard work that goes into the code development of the Web site. In some respects the issues are not all that different than designing a client/server farm. The primary differences are in planning for different server loads, a somewhat different set of tools, different clients, and the potential for the environment to change rapidly.

☺☺☺

Case Study- Dealing an E-Commerce Sample Application with Complete Coding

- Building the Data Table
- Building the HTML Form
- Programming the Script Code
- Testing the Application
- Managing the Application

We are going to build a very simple e-commerce application based on Active Server Pages and SQL Server. This will help to get our feet wet with the ASP development environment.

Our sample application will be a simple form to purchase a subscription to a publication. This form will take in name and address information and credit card data.

Building the Data Table

The first thing we will need is a simple database table that we can insert our subscriptions into. The obvious fields are in the table for the subscriber's name, address, credit card information, etc., as shown in Listing 1.

Listing 1

Subscription Database Table

```
CREATE TABLE dbo.Subscriptions (  
  IdSubscription int IDENTITY (1,1) NOT NULL,  
  ChrFirstName varchar (100) NULL,  
  ChrLastName varchar (100) NULL,  
  ChrAddress varchar (150) NULL,  
  ChrCity varchar (100) NULL,  
  ChrState varchar (10) NULL,  
  ChrZipCode varchar (15) NULL,  
  ChrPhone varchar (25) NULL,  
  ChrEmail varchar (100) NULL,  
  ChrCardName varchar (150) NULL,  
  ChrCardType varchar (50) NULL,  
  ChrCardNumber varchar (25) NULL,  
  ChrExpDate varchar (50) NULL,  
  IntProcessed tinyint NULL DEFAULT 0,  
  /* Default to 0 */  
  dtEntered datetime NULL  
  DEFAULT GETDATE(),  
  /* Default to Current date */  
  intLength tinyint NULL  
)
```

A couple of status fields are included in the table. The intProcessed field would be used to flag the order are processed so an indication of what subscriptions have been retrieved can be easily tracked. This field should be defaulted to 0, to indicate "unprocessed." The next status field is the dtEntered field. This defines the date the subscription was entered into the database. It should be defaulted to the current date.

If you are not familiar with the SQL Server 7.0 , Please follow the instructions to create the table in your own database.

Create a database called Manorama and then insert the table Subscription in the listing one in to the database.

1. Click the Start Button open the Enterprise Manager in SQL Server 7.0 as shown in Fig

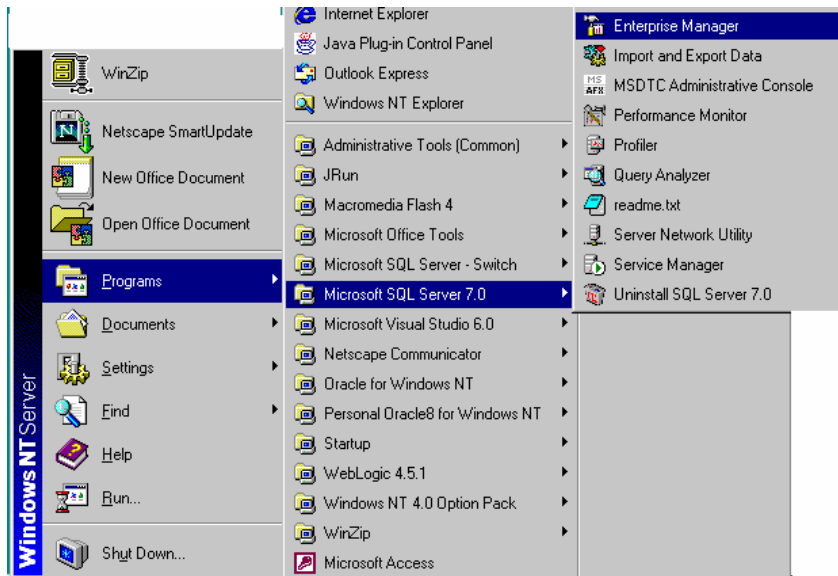

2. Enterprise Manager Dialog Box Will open and look like this.

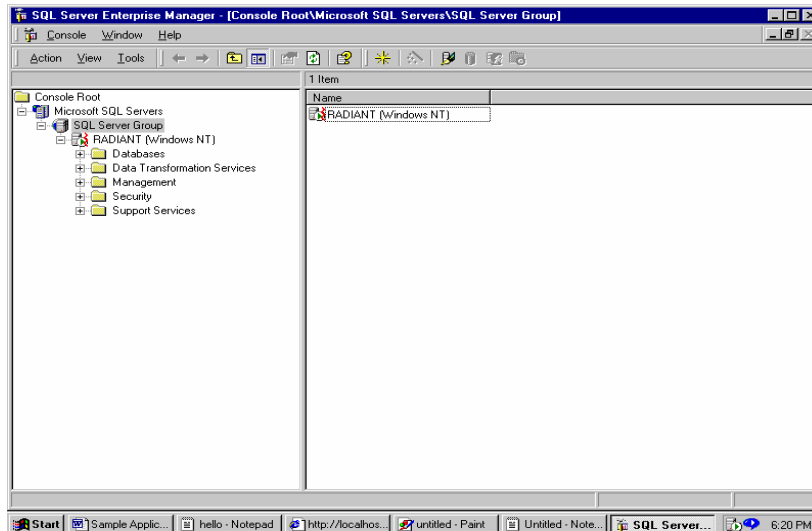

3. Right Click the Database Option then the New Database Option Button will open

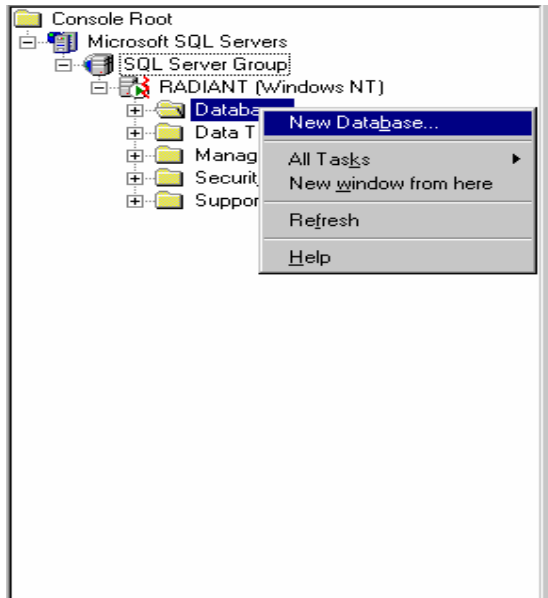

4. Enter the Name of the Database called Manorama as shown in Fig and then click OK.

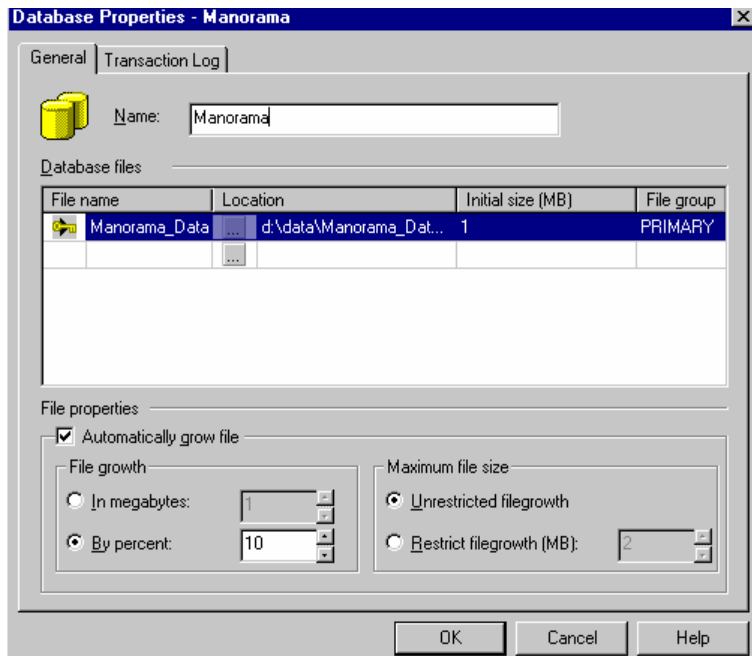

5. Now Your database named Manorama has been entered in to the Databases collection of the SQL Server as shown in Fig.

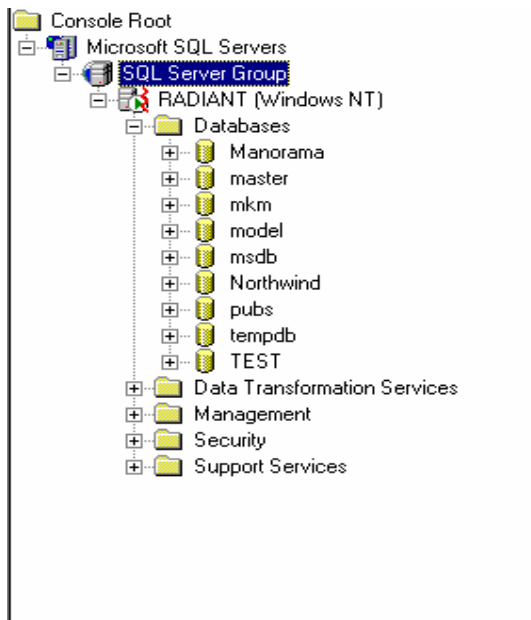

6. You have created Your own database in the server , Now you have to place the table called Subscriptions into the database which is listed in the Listing 1. To do that you have to open the Query Analyzer in the SQL Server as shown in the Fig.

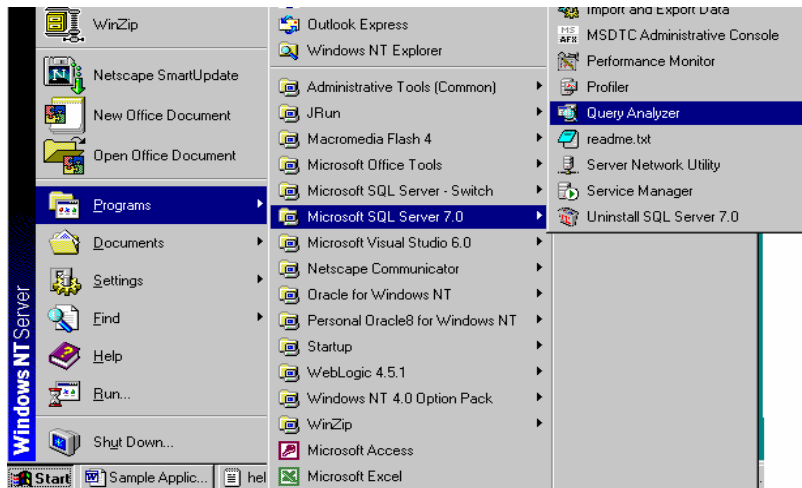

7. Query Analyzer Window will open and look like this , and in the DB option select the Database what you have created.

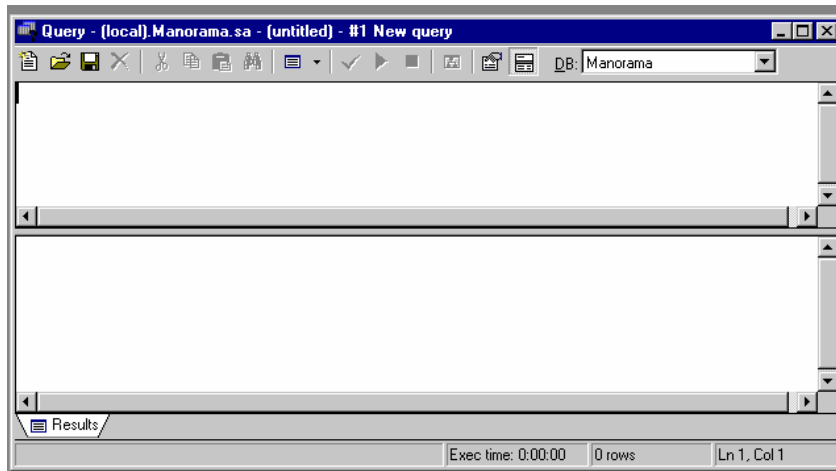

8. Now You have to create the query (i.e, type the Listing 1) and execute the query and see the Results in the Result Dialog Box. You will get the message like Command succeeded successfully as shown in Fig.

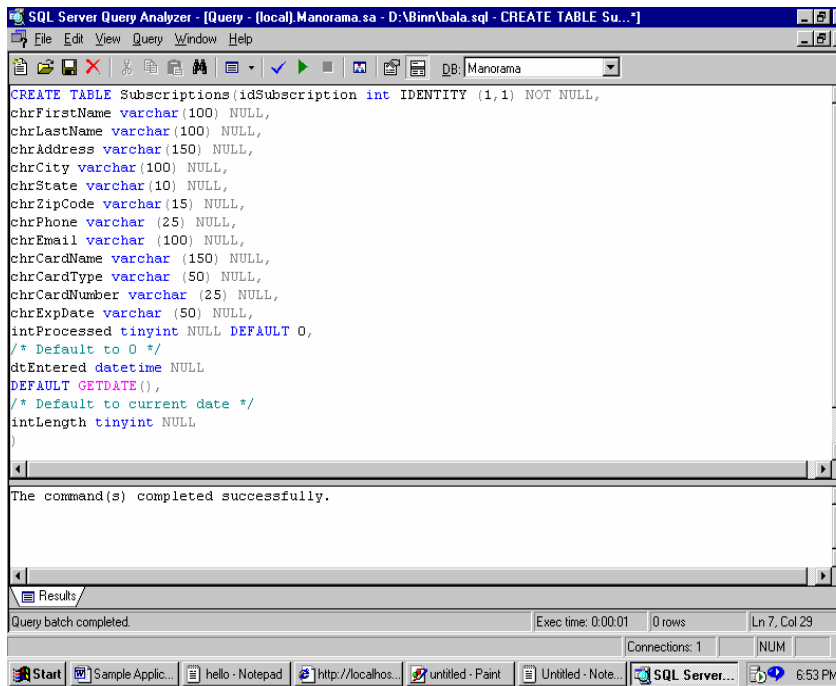

9. So for you created a Database called Manorama and into that database you have inserted the table Subscription . Now close the Query Analyzer Window then Open the Enterprise Manager Window then open the Manaorama data base where you can see the Subscription table along with other table as shown in Fig.

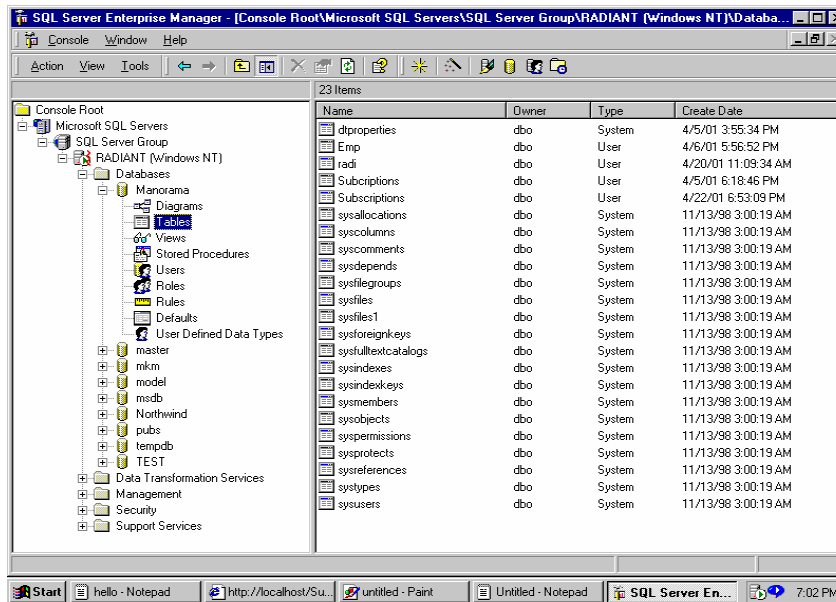

10. Then Open the Subscription table you can see the Table Properties. With this your Simple database Design is over , Now you can enter into the Application Design.

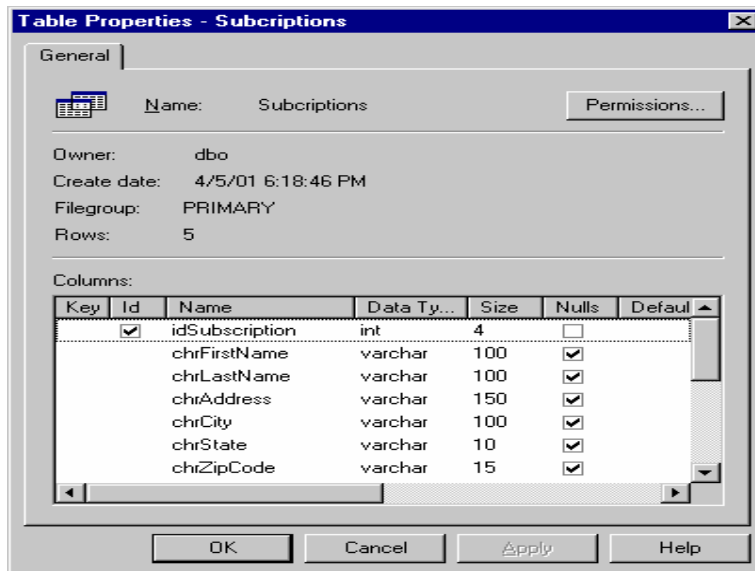

Building the HTML Form

Create the Active Server Page called subscription.asp .Once that is done, a new file is created on the Web Server. We are now ready to begin building the HTML structure of the page. A basic template for the page is created when the ASP page is created. We can begin editing in Visual InterDev. We have three options – Design and Quick View and source view. In general , the Source View will be utilized for all development.

The Design View is used for WYSIWYG HTML building. Quick View is utilized for viewing the HTML in a browser interface, but note that no ASP code is processed.

To build the HTML page, we will need to create an HTML form and HTML elements on the page. Then we will build a script page to process the data entered by the user.

The first part of the page is straightforward, as shown in Listing 2. The standard HTML headers for the page are created. We also start out the form by setting it to post results to ProcessSub.asp page, which will process the subscription.

Session Variables

In standard Web technology there is no simple way of remembering state data between Web pages. For example, if the shopper enters in their zip code and then starts browsing through the rest of the site, we would have to do a lot of work to track that data on the URL or through the use of Hidden HTML elements. Fortunately, in IIS/ASP, Microsoft built in the Session variable capability. This allows us to save data in a variable that stays active for the users entire visit to the web site. All we do is set the variable on one page and then retrieve the value as needed on subsequent pages. Note that sessions have a timeout setting that is defaulted to 30 minutes. In reality, we never know when the visitor has left the site, so we want the session data to disappear if there is no activity for that session for the specified timeout period.

Listing 2

Subscription.asp Page

```
<%@ Language = VBScript %>
<HTML>
<HEAD>
<META NAME = "GENERATOR" Content = "Microsoft Visual Studio 6.0">
<HEAD>
<BODY>
<BR><BR>
<CENTER>
<!--Setup the Header →
<font size = "4" color = "blue"><b>
Manorama Publication
</b></font>
<!--Start the form that will post to the ProcessSub.asp page →
<form method = "post" action = "ProcessSub.asp">
```

The next section of the page is the table that contains the form for displaying the input fields of the subscription page. There are several key actions on the page. First, if the user enters invalid data, we want to be able to send him back to this form and have the data he entered repopulated into the form.

The repopulation is done by reading session variables set in the ProcessSub.asp page when the data is in error. Our first challenge is the length of the subscription (set in intLength). If the user selected two-year subscriptions, then we will want to set the proper radio button. If not, then the one-year option will be set.

Listing 3

Subscription.asp continued

```
<!-- Next the table starts that will layout the data entry form -->
<table border =1>
<!-- Subscription Length -->
<tr>
  <td align = "right" > Subscription Length:</td>
  <td>
<%
  'Check to see if a length was set. If so then default the radio button
selected
  if session("intLength") = "1" then
    CheckOne = "Checked"
    Flag = 1
  end if
  if session("intLength") = "2" then
    ChekTwo = "Checked"
    Flag = 1
  end if
  if session("intLength") = "3" then
    CheckThree = "Checked"
    Flag =1
  end if
  ' If this is the first time the form is
  ' displayed in the session then default to
  ' a length of one year.
  if Flag<> 1 then CheckOne = "Checked"
%>
  <!-- Radio buttons for selecting the length -->
  <input type = "radio" value ="1" name ="intLength" <%= CheckOne%>One Year
  <input type = "radio" value ="2" name ="intLength" <%= CheckTwo%>Two year
```

```
<input type = "radio" value = "3" name = "intLength" <%= CheckThree%>Three Year
</td>
</tr>

<!-- First Name -->
<tr>
  <td align = "right">First Name:</td>
  <!-- Input field for the first name -->
  <td><input type = "text" value = "<%=session("chrFirstName")%" name =
"chrFirstName"></td>
</tr>

<!-- Last Name -->
<tr>
  <td align = "right">Last Name:</td>
  <!-- Input field for the last name -->
  <td><input type = "text" value = "<%=session("chrLastName")%" name =
"chrLastName"></td>
</tr>

<!-- Address -->
<tr>
  <td align = "right">Address:</td>
  <!-- Input field for the address -->
  <td><input type = "text" value = "<%=session("chrAddress")%" name =
"chrAddress"></td>
</tr>

<!-- City -->
<tr>
  <td align = "right">City:</td>
  <!-- Input field for the city -->
  <td><input type = "text" value = "<%=session("chrCity")%" name =
"chrCity"></td>
</tr>

<!-- State -->
<tr>
  <td align = "right">State:</td>
  <!-- Input field for the State -->
  <td><input type = "text" value = "<%=session("chrState")%" name =
"chrState"></td>
</tr>

<!-- Zip Code -->
<tr>
```

```

        <td align = "right">Zip Code:</td>
        <!-- Input field for the zip code -->
        <td><input type = "text" value = "<%=session("chrZipCode")%" name =
"chrZipCode"></td>
    </tr>

<!-- Phone Number -->
<tr>
    <td align = "right">Phone:</td>
    <!-- Input field for the phone Number -->
    <td><input type = "text" value = "<%=session("chrPhone")%" name =
"chrPhone"></td>
</tr>

<!--Name on Card -->
<tr>
    <td align = "right">Name on Card:</td>
    <!-- Input field for the first name -->
    <td><input type = "text" value = "<%=session("chrCardName")%" name =
"chrCardName"></td>
</tr>

```

A process similar to the length of subscription logic needs to take place for the card type .If the user selected Master Card or American Express, then we want to reselect those options when the user is returned to the form.

Listing 4

Subscription.asp continued

```

<!-- Input field for the Credit Card type -->
<tr>
    <td align = "right">Card Type:</td>
    <td>
    <%
'Check to see which card was selected previously
'if there was an error
if session("chrCardType") = "Visa" then
    SelVisa = "Selected"
end if
if session("chrCardType") = "MasteCard" then

```

```
SelMC = "Selected"
end if
if session("chrCardType") = "AmEx" then
  SelAmEx = "Selected"
end if

%>

<!-- Select box for the type of cards-->
<select name ="chrCardType">
  <option value = "Visa" <%=SelVisa%> >Visa
  <option value = "MasterCard" <%=SelMC%> >Master Card
  <option value = "AmEx" <%=SelAmEx%> >Americal Express
</select>

</td>
</tr>

<!-- Credit Card Number -->
<tr>
  <td align = "right">Card Number: </td>
  <!-- Input field for the credit card number -->
  <td><input type = "text" value = "<%=session("chrCardNumber")%>" name = "chrCardNumber"></td>
</tr>

<!-- Credit card expiration date-->
<tr>
  <td align = "right">Expiration Date:</td>
  <!-- Input field for the expiration date -->
  <td><input type ="text" value ="<%=session("chrExpDate")%>" name ="chrExpDate"></td>
</tr>
```

The last section of our page is the HTML submit button for sending the form data to the server. Then the form and the page are closed out.

Listing 5

The end of Subscription.asp

```
<!-- Submit button -->
```

```
<tr>
  <td colspan = "2" align = "center">
    <input type = "submit" value = "Subscribe!" name = "submit">
  </td>
</tr>
</table>
</center>
<!--Closing tag for the end of the form -->
</form>
</body>
</html>
```

The input page is fairly straightforward. If you are new to ASP coding, then mixing script code and HTML tags in the same page might take some getting used to. But it is precisely this powerful integration that makes ASP such a rich development for building e-commerce Web applications.

Programming the Script Code

Now the real programming fun begins on the processing of the subscription request. Our goal in this page is several-fold. First, we want to retrieve the data from the user and validate it. We want to ensure that she has entered in values for all required fields, and when possible we want to validate that the data is correct.

Second, we want to then give feedback to the user if there is an error. A message will be displayed telling the user certain fields are incorrect. And, we will provide a link back to the subscription page for the user. That is where the session variables and repopulating the subscription form come into play.

Third, if the data is valid, we want to thank the user. In this case, we are going to re-display the input data for good customer service feedback. And of course, we need to be sure to insert the subscription data into the database for later retrieval.

As with the Subscription.asp page, the Processsub.asp page opens up with basic HTML tagging . Listing 6 shows the page code.

Listing 6

ProcessSub.asp

```
<% Language = VBScript %>
<HTML>
```

```
<BODY BGCOLOR = "#FFFF80">
```

Our first task is to retrieve the data from the form, We utilize the Request object to retrieve the data and reference the field names on the form. The data is stored in variables for later use.

NOTE

Variables do not have to be used to store the form data. The Request object could be used throughout the page. But, the variables use makes for easier manipulation of the data later.

Listing 7

```
<%  
    'Retrieve all of the data that the user entered by using the request object.  
    intLength = Request("intLength")  
    chrFirstName = Request("chrFirstName")  
    chrLastName = Request("chrLastName")  
    chrAddress = Request("chrAddress")  
    chrCity = Request("chrCity")  
    chrState = Request("chrState")  
    chrZipCode = Request("chrZipCode")  
    chrPhone = Request("chrPhone")  
    chrEmail = Request("chrEmail")  
    chrCardName = Request("chrCardName")  
    chrCardType = Request("chrCardType")  
    chrCardNumber = Request("chrCardNumber")  
    chrExpDate = Request("chrExpDate")
```

The next step is to check each field and validate it. For most of the fields we are simply going to ensure the field is not blank. For the state field, we do a little more validation to ensure that the length is not more than two characters. On the credit card expiration date we can use the IsDate function to validate that it is a valid date.

Listing 8

ProcessSub.asp Continued

```
'Check to see if the first name was entered
```

```
if chrFirstName = "" then  
    'Give an error if not  
    strError = "You did not enter in your first name.<br>"
```



```
end if

if chrLastName = "" then
    strError = strError & "You did not enter in your last name.<br>"
end if

if chrAddress = "" then
    strError = strError & "You did not enter in your Address.<br>"
end if

if chrCity = "" then
    strError = strError & "You did not enter in your City.<br>"
end if

if chrState = "" or len(chrState)>2 then
    strError = strError & "You did not enter in a valid state.<br>"
end if

if chrCardName = "" then
    strError = strError & "You did not enter in the name on your credit
card.<br>"
end if

if chrCardNumber = "" then
    strError = strError & "You did not enter in your Credit Card Number.<br>"

end if

if (chrExpDate = "") or (isdate(chrExpDate) = false) then
    strError = strError & "You did not enter in a valid Credit card Expiration
date.<br>"
end if
```

Now that the data is validated, we are ready to take appropriate action. We can check the strError variable to see if it is set. If it is, then there was an error. If not, then there was no error.

Now we check to see if there are any errors.

```
If strError <> "" then
%>
```

If there is an error, we simply display the appropriate message and write out the error string. The key though is ensuring we have the data from the form stored so that it can be retrieved and displayed when the user returns to the form. The best way to do this is with session variables, which will stay alive while

the user's session is still in progress. Then on the subscription form we can retrieve those values and display them.

Listing 8

ProcessSub.asp continued

```
<!-- Note the error-->
<B><font color = "red">
There is an error in your subscription request:<BR><BR>
</B></font>

<%
    'Write out the error messages
Response.Write strError
%>
<!-- Link back to the Subscription page -->
<BR>
Click <a href = "Subscription.asp">here</a> to update.
<%
    'Set session variables to the subscription form cab be re-populated

Session("intLength") = request("intLength")
Session("chrFirstName") = request("chrFirstName")
Session("chrLastName") = request("chrLastName")
Session("chrAddress") = request("chrAddress")
Session("chrCity") = request("chrCity")
Session("chrState") = request("chrState")
Session("chrZipCode") = request("chrZipCode")
Session("chrPhone") = request("chrPhone")
Session("chrEmail") = request("chrEmail")
Session("chrCardName") = request("chrCardName")
Session("chrCardType") = request("chrCardType")
Session("chrCardNumber") = request("chrCardNumber")
Session("chrExpDate") = request("chrExpDate")

else
%>
```

If the data was all valid then we are ready to process the subscription form. An appropriate thank you message is displayed and then a recap of the form data is displayed.

Listing 9**ProcessSub.asp**

```

<!-- Thank the Customer for the order -->
<font size = "4" color = "blue"> Thank You for your Order!
It will be processed immediately.</font>
<!-- Redisplay the data entered into the subscriptin -->
<BR><BR>
<TABLE>
<tr><td align = "right"><B>Name:</b></td>
<td><i> <% = chrFirstName & " " & chrLastName %></i></td></tr>

<tr><td align = "right"><B> Address: </b></td>
<td><i> <% = chrAddress %></i></td></tr>

<tr><td align = "right"><B> City: </b></td>
<td><i> <% = chrCity %></i></td></tr>

<tr><td align = "right"><B> State: </b></td>
<td><i> <% = chrState %></i></td></tr>

<tr><td align = "right"><B> Zip Code: </b></td>
<td><i> <% = chrZipCode %></i></td></tr>

<tr><td align = "right"><B> Phone: </b></td>
<td><i> <% = chrPhone %></i></td></tr>

<tr><td align = "right"><B> Email: </b></td>
<td><i> <% = chrEmail %></i></td></tr>

<tr><td align = "right"><B> Card Name: </b></td>
<td><i> <% = chrCardName %></i></td></tr>

<tr><td align = "right"><B> Card Type: </b></td>
<td><i> <% = chrCardType %></i></td></tr>

<tr><td align = "right"><B> Card Number: </b></td>
<td><i> <% = chrCardNumber %></i></td></tr>

<tr><td align = "right"><B> Expiration Date: </b></td>
<td><i> <% = chrExpDate %></i></td></tr>

```

Now we are ready to do the important step of inserting the data into the database. The first step is to create an ADO connection object to the database. Be sure to create the DSN. Note in this case a file DSN is being utilized, but a system DSN could be created instead. Be aware that user DSNs operate only under the context of the user for which they were created, rendering them unsuitable for which they were created, rendering them unsuitable for use within IIS.

Next we have to sanitize the data for insertion into the database. We have to ensure that any single quotes that may be entered are doubled up so they can be inserted and not confused as delimiters. Examples of this problem would include last names (e.g., O'Brien), cities, addresses, etc. Using the Replace command makes it easy to replace these single quotes with doubles. In this case we will check the First Name, Last Name, Address, Card name, and City.

Tip

SQL server will interpret two single quotes together("") as only one single quote. We will need to double up all single quotes that are part of the data to be stored in a field. Our values that are being inserted should start with a single quote and end with one as well.

Once the data is ready, we can build a SQL statement for inserting the data into the database. And then we are ready to execute the SQL statement.

Listing 10

ProcessSub.asp continued

```
<%  
    'Create an ADO database connection  
    set dbSubs = Server.CreateObject("ADODB.CONNECTION")  
    'Open the connection using out ODBC file DSN  
    dbSubs.Open "Provider=SQLOLEDB.1;Persist Security Info=true;User ID=SA;Initial  
    Catalog=Manorama;Data Source=RADIANT"  
  
    'If any of our names have a single quote, we will need to double it to insert it into the database  
    chrFirstName = replace(chrFirstName, "'", "'')  
    chrLastName = replace(chrLastName, "'", "'')  
    chrAddress = replace(chrAddress, "'", "'')  
    chrCardName = replace(chrCardName, "'", "'')  
    chrCity = replace(chrCity, "'", "'')
```

'Sql insert statement to insert the subscription data into the database

```
sql = "insert into Subscriptions(" & " chrFirstName," & " chrLastName, " & "
chrAddress, " & " chrCity, " & " chrState, " & " chrZipCode, " & " chrPhone,"
& " chrEmail," & " chrCardName," & " chrCardType, " & " chrCardNumber, " & "
chrExpDate, " & " intLength) " & _
"values(" & " '" & chrFirstName & "','" & chrLastName & "','" & chrAddress &
',' & chrCity & "','" & chrState & "','" & chrZipCode & "','" & chrPhone &
',' & chrEmail & "','" & chrCardName & "','" & chrCardType & "','" &
chrCardNumber & "','" & chrExpDate & "','" & intLength & ")"
dbSubs.execute(sql)
end if
%>

</body>
</html>
```

That is it for the user side programming. In Part III, we will explore how we can utilize Web based reporting to retrieve the subscriptions.

Testing the Application

Now we are ready to begin testing. Calling the Subscription.asp page from your Web server accesses the Web page as shown in Fig

Manorama Publication

Subscription Length:	<input checked="" type="radio"/> One Year <input type="radio"/> Two year <input type="radio"/> Three Year
First Name:	<input type="text"/>
Last Name:	<input type="text"/>
Address:	<input type="text"/>
City:	<input type="text"/>
State:	<input type="text"/>
Zip Code:	<input type="text"/>
Phone:	<input type="text"/>
Email Address:	<input type="text"/>
Name on Card:	<input type="text"/>
Card Type:	Visa <input type="button" value="v"/>
Card Number:	<input type="text"/>
Expiration Date:	<input type="text"/>
<input type="button" value="Subscribe!"/>	

Now we need to go ahead and enter data into the form. We will want to enter in some invalid data so that we can test the error handling. The following Fig shows the form filled out with sample data. Note that the expiration date is invalid. When done, we need to submit the form to the ProcessSub.asp page

Subscription Length:	<input checked="" type="radio"/> One Year <input type="radio"/> Two year <input type="radio"/> Three Year
First Name:	BalaMurugan
Last Name:	Shanmugham
Address:	93.BharathiNagar
City:	Tirunelveli
State:	TN
Zip Code:	627007
Phone:	0462-532226
Email Address:	gau_tham@hotmail.com
Name on Card:	NameCard
Card Type:	Visa <input type="button" value="v"/>
Card Number:	4242424242424242
Expiration Date:	11/99x
<input type="button" value="Subscribe!"/>	

The ProcessSub.asp page will process the data. And, in fact, if all is working properly we should see an error message indicating the expiration date is invalid.

The Following Fig shows the error message.

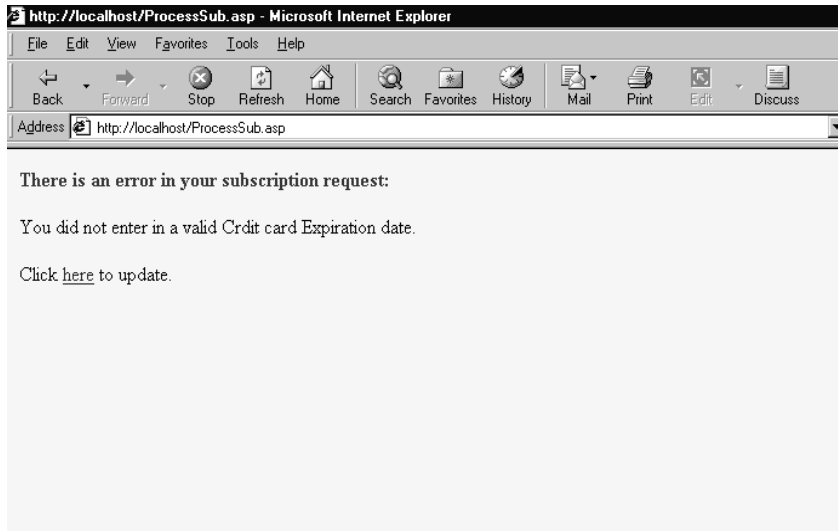

Now we can click on the error link and go back to the subscription page. When we do, the data form should be re-populated with our subscription data, error messages, and all. The following Fig shows a correctly entered subscription.

Tip

You may want to have the field name highlighted in red to help indicate on the subscription form which field is invalid

Subscription Length:	<input checked="" type="radio"/> One Year <input type="radio"/> Two year <input type="radio"/> Three Year
First Name:	BalaMurugan
Last Name:	Shanmugham
Address:	93,BharathiNagar
City:	Tirunelveli
State:	TN
Zip Code:	627007
Phone:	0462-532226
Email Address:	gau_tham@hotmail.com
Name on Card:	NameCard
Card Type:	Visa
Card Number:	4242424242424242
Expiration Date:	05/11/2001
<input type="button" value="Subscribe!"/>	

Now we can correct the data and then resubmit the subscription data. When we do, the thank you response is displayed with a recap of the data. Fig shows the thank you page. And, we should also be able to verify that the data went into the database.

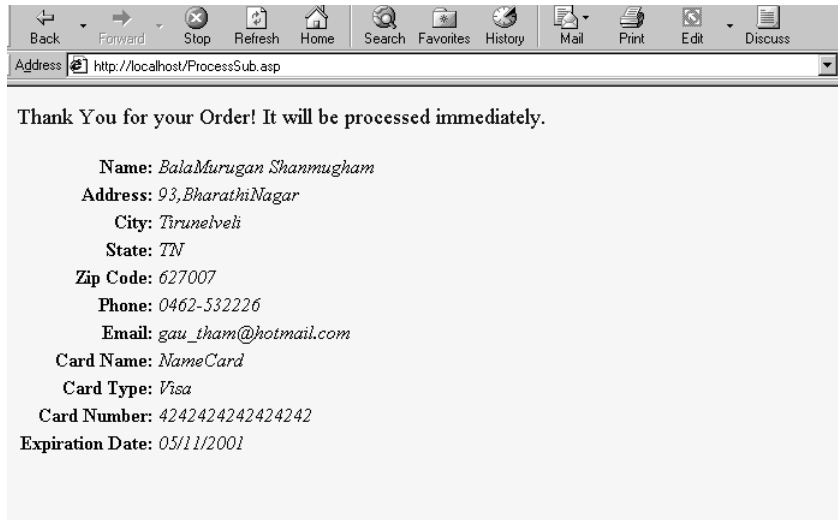

Now that we have completed the user experience, we need to worry about the back end management of the subscription data. We will need a way to retrieve the subscriptions.

Managing the Application

The last piece of our e-commerce sample application is the reporting form. The purpose of the form is to report out the subscription data entered since the last subscriptions were processed. And, it will give an option for the user to mark the current listing of subscriptions as processed. Listing 11 shows the code for the SubReport.asp page.

Listing 11

SubReport.asp

```
<%@ Language = VBScript %>
<HTML>
<HEAD>
<META NAME = "GENERATOR" Content = "Microsoft Visual Studio 6.0">
</HEAD>
<BODY>
```

The first step is to create our database connection. Then we need to check and see if we are to mark subscriptions as processed. If so, then there will be an idSubscription parameter on the URL. This is set late in the code when the clear option is selected. If the parameter is set, then all subscriptions that have ID less than or equal to the subscription ID will be cleared. Anything above that will remain unprocessed and be displayed.

Listing 12

SubReport.asp continued

```
<%  
'Create an ADO database connection  
set dbSubs = Server.CreateObject("ADODB.CONNECTION")  
set rsSubs = Server.CreateObject("ADODB.RECORDSET")  
'Open the connection using our ODBC file DSN  
dbSubs.Open "Provider=SQLOLEDB.1;Persist Security Info=true;User ID=SA;Initial  
Catalog=Manorama;Data Source=RADIANT"  
'Retrieve any subscription IDs on the URL  
idSubscription = Request("idSubscription")  
'Check to see if there is a value  
if idSubscription<> "" then  
'Built an SQL update statement to pprocess the subs.  
sql = "update Subscriptions set intProcessed = 1 where " & "idSubscription <= "  
& idSubscription  
'Execute the SQL statement  
dbSubs.execute sql  
end if
```

Next we are ready to retrieve all of the subscriptions in the system that have not been processed. A SQL statement is built with the appropriate where clause and then the SQL statement is executed with a record set returned.

```
'Create a SQL statement to retrieve any unprocessed subscriptions  
  
sql = "select * from Subscriptions where intProcessed = 0"  
'Execute the statement and retrieve the record set  
set rsSubs = dbSubs.Execute(sql)  
  
%>
```

Next we are ready to begin the structure of the table that will be utilized to display the unprocessed subscriptions. The formatting is fairly simple, with field names on the left and the data on the right.

Tip

You might want to put some logic in place to have the subscriptions listed out in several columns instead of just one. If you are processing many subscriptions, that will reduce the number of pages that will be displayed.

Listing 13

SubReport.asp Continued

```
<!-- Start the table to display the Subs. -->
<Table border = "1">
<%

'Check to see if no subs are returned if rsSubs.EOF then
if rsSubs.EOF then
'If so, then write
Response.Write "No Subscriptions to Report."
else
'Loop through the Subs
do until rsSubs.eof

%>

<!-- Display the subscription data -->
<TR>
<TD align = "right">Firt Name:</TD>
<TD> <% = rsSubs("chrFirstName")%></TD>
</TR>

<TR>
<TD align = "right">Last Name:</TD>
<TD> <% = rsSubs("chrLastName")%></TD>
</TR>

<TR>
<TD align = "right">Address:</TD>
<TD> <% = rsSubs("chrAddress")%></TD>
</TR>

<TR>
<TD align = "right">City:</TD>
<TD> <% = rsSubs("chrCity")%></TD>
</TR>
```

```
<TR>
<TD align = "right">State:</TD>
<TD> <% = rsSubs("chrState")%></TD>
</TR>

<TR>
<TD align = "right">Zip Code:</TD>
<TD> <% = rsSubs("chrZipCode")%></TD>
</TR>

<TR>
<TD align = "right">Phone:</TD>
<TD> <% = rsSubs("chrPhone")%></TD>
</TR>

<TR>
<TD align = "right">Email:</TD>
<TD> <% = rsSubs("chrEmail")%></TD>
</TR>

<TR>
<TD align = "right">Card Name:</TD>
<TD> <% = rsSubs("chrCardName")%></TD>
</TR>

<TR>
<TD align = "right">Card Number</TD>
<TD> <% = rsSubs("chrCardNumber")%></TD>
</TR>

<TR>
<TD align = "right">Date Entered:</TD>
<TD> <% = rsSubs("dtEntered")%></TD>
</TR>

<TR>
<TD align = "right">Subscription Length:</TD>
<TD> <% = rsSubs("intLength")%></TD>
</TR>

<TR>
<TR>&nbsp;</TD>
```

```
<TR>&nbsp;</TD>
</TR>
response.Write("Welcome")
```

In order to be able to clear the listed subscriptions, we need to save the ID of the last subscription displayed so that it can be passed back to this page. The ID of the subscription is stored in the idSubscription variable. Then we advance the record set.

Listing 14

SubReport.asp Continued

```
<%
'Store the last subscription id
idSubscription = rsSubs("idSubscription")
'Move to the Next sub
rsSubs.MoveNext
  loop
end if
%>
</table>
<BR><BR>
```

Finally we build a link back to this page with the ID of the last subscription so this report can be cleared. Note that the ID of the subscription is stored on the URL with the idSubscription parameter.

Listing 15

SubReport.asp Continued

```
<!-- Link to this page with the last Subscription ID -->
Click <a href = "SubReport.asp?idSubscriptionv=<%=
idSubscription%>">here</a>to clear this report.
</BODY>
</HTML>
```

The page is then ready to be run. Make sure the database is seeded with some sample subscriptions. Figure shows the report page with the sample data. Note the link to clear the report.

Subscription Length:	1
First Name:	BalaMurugan
Last Name:	Shanmugham
Address:	93,BharathiNagar
City:	Tirunelveli
State:	TN
Zip Code:	627007
Phone:	0462-532226
Email:	gau_tham@hotmail.com
Card Name:	NameCard
Card Number	4242424242424242
Date Entered:	4/22/01 4:41:38 PM
Subscription Length:	1

Click [here](#) to clear this report.

Go ahead and click on the link to clear the subscriptions. When you do so, the page is re-called with the ID of the last subscription on the URL. Then the section of code is run to mark these subscriptions as processed. You should be able to check the processed fields in the database to verify they are set to 1. Any new subscriptions will be displayed or a message is displayed indicating no more subscriptions are available to be displayed.

We might want to provide a richer interface for searching for subscriptions, processed and unprocessed. Date entered, length of subscription, etc., may be offered as options to search by.

Summary

Our sample application hits on the key tools we will be utilizing for development ASP, SQL Server, HTML, and a browser. For a site that needs a simple way to request subscriptions, memberships, or other data, this type of form will be more than adequate.

A couple of things should be considered when implementing this type of form. First is security. Certainly the form should be encrypted with Secure Socket Layer (SSL) to ensure the data cannot be easily sniffed on the Internet. And, make sure your usernames and passwords to access the database are not readily guessed or easily found out. And. The manager page should not be readily accessible to just anyone. You will want to secure it either with a password-protected form using SQL, or else by using Windows NT Authentication and an Access Control List (ACL) on the directory where the manager page exists.

Second, you want to provide an order number back to the person who has just ordered so they can make any queries referencing that number. The best way to implement that would be to build a stored procedure that inserts the subscription data and returns a parameter that is the ID of the identity column in the table. That can then be displayed in the thank you message to the user.

Finally, if you want to provide immediate processing of the credit card data you might want to consider using tools such as CyberCash or HP/Veriphone . Then, if the user's order is cleared, you can immediately give them online access to content, etc.

❧

Case Study 3

Thuli India On-line Consultancy**Data Base Design****Enrolment Table**

Field Name	Data Type
Candname	Text
Refid	Number
Sex	Text
DOB	Number
Address1	Text
Phno	Number
Mailed	Text
Qual	Text (Only B.E/MCA)
Exp	Number

Company Master

Field Name	Data Type
Compname	Text
Compid	Number
Address	Text
mailid	Text
contactperson	Text
Phno	Number

Qualified List

Field Name	Data Type
Candname	Text
Candid	Number
Sex	Text
Dob	Number
Address	Text
Phno	Number

Pref_lang	Text
Qual	Text
Exp	Number
Remark	Text

Java Candidate

Field Name	Data Type
Candname	Text
Candid	Number
Sex	Text
Dob	Number
Address	Text
Phno	Number
Pref_lang	Text
Qual	Text
Exp	Number
Remark	Text

NOTE:

After the online exam, as per the candidate's preferable s/w area such as (Java, ASP, JSP, EJB etc.) their info are stored in individual tables.

Recruited Candidate

Field Name	Data Type
Candid	Number
Compid	Number
Address	Text
Phno	Number
Mailid	Text
Recr.Date	Date
Qual	Text
Job Title	Text
Exp	Number
Pref_lang	Text

DATA FLOW DIAGRAM

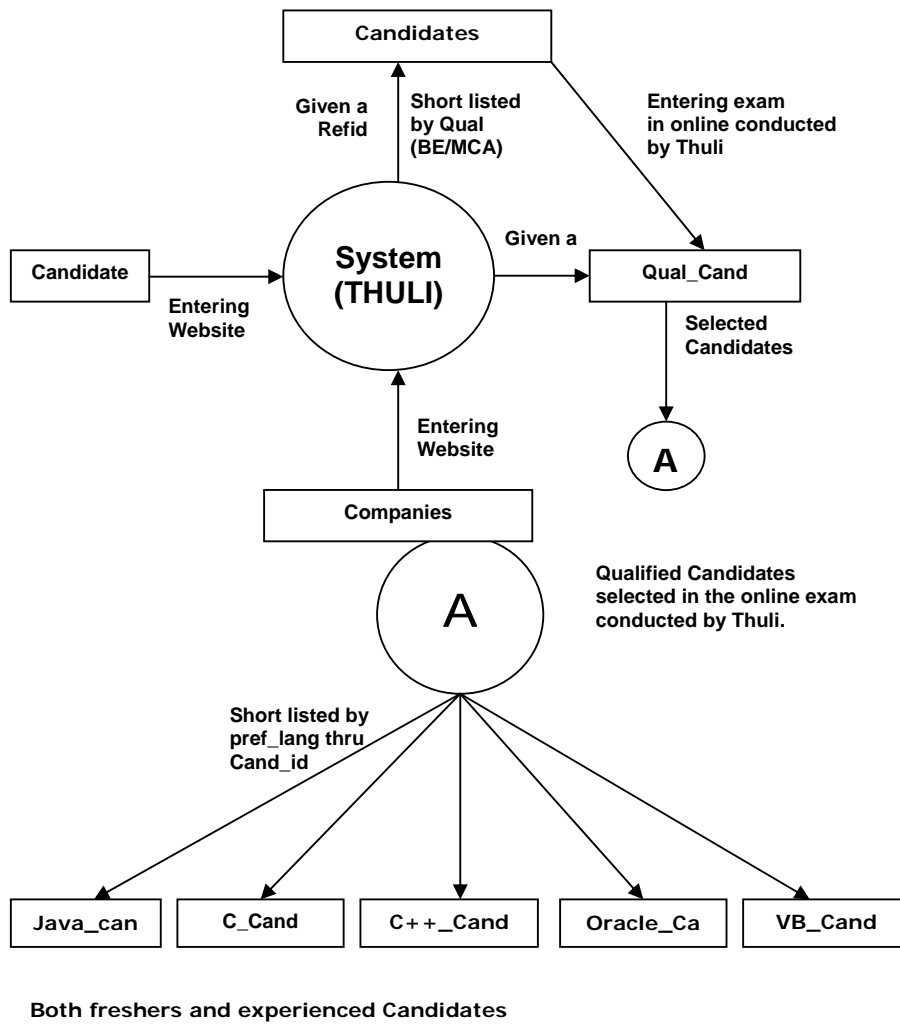

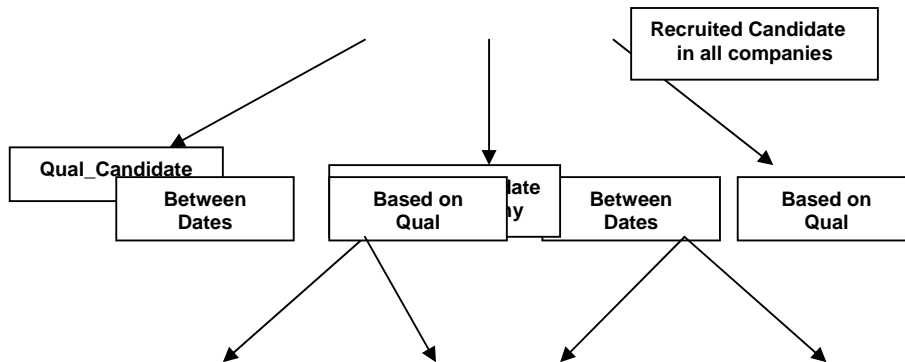
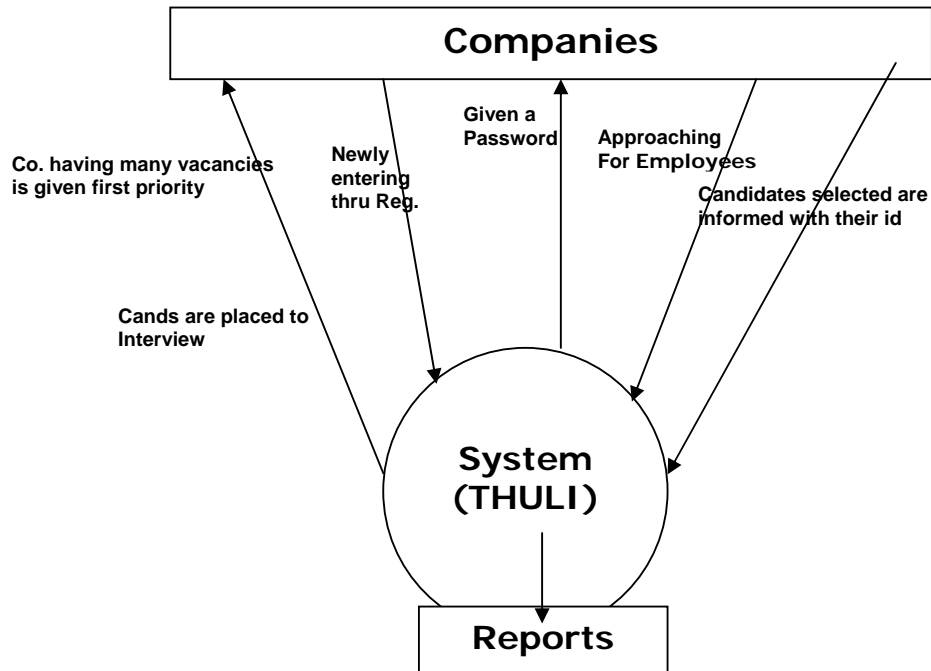

Project Description

The project of "SEVICE MAINTENANCE SYSTEM" deals with the recruitment of candidates to the company that is tied up with ThuliIndia by online. It includes the entry of the jobseeker's Personal Information, Technical Profile and Company Information. And also in this project, according to jobseeker's area of interest in IT line, the information are maintained in separate tables. Jobseekers who are registered are recruited to the company with respect to the number of vacancies required by them.

PROBLEM DESCRIPTION

The candidate who enters into the website of ThuliIndia, request him/her through the registration form. The candidates those who are M.C.A/B.E would be short listed and the information are maintained in a table.

If the candidate is a new one, then he is given a username and password. And then only he/she could be registered at ThuliIndia by submitting his/her resume. If the candidate who has been already registered can logon using his/her unique id and password to view the opportunities.

In the same way employer i.e company approaches ThuliIndia after given a unique id and password. Company Information are submitted in the specified page. Company info includes the required number of employers, job title, URL, Email_id, Area of interest in software industry etc. According to the number of vacancies, experience required, area of interest, registered candidates are recruited to the specified Company, tied up with ThuliIndia.

Before this, candidates(M.C.A/B.E) are split up with respect to their area of interest in IT Industry. And their information are maintained in separate tables. Online exam is also conducted and after the registration to test the skill of the candidates. After the selection of candidates in the exam they are given a unique Registration Number by which he/she has to mention for all correspondence.

Webmaster page is also maintained by the owner. It is having a unique password to enter. In this there should be a facility to send mail to the selected candidate and the information to which company he has been selected. ThuliIndia registers candidates by

- Accepting their resumes through Registration .
- They should attend the Online exam conducted by Thuli.
- Selected candidates are given a Register number which he/she has to maintain for all correspondence.
- Mailing facility to the selected candidate.
- The main feature in our system is recruiting registered candidates in the company according to the company's requirements.

SYSTEM ANALYSIS

Existing System:

At present the processes are done manually. It is more complicated to do the process in time. The concern has one computer and daily the staff checks the mails sent by the candidates/employers and the staff

sends the intimation or information (if any) to them. The test is handled by ThuliIndia in person. After the result of the test the candidates are given a registration number which he/she mention for all correspondence. And the concern maintains the registered candidates information .

Feasibility Study:

Preliminary investigation examine project feasibility, the likelihood system will be useful to the organization. There are three different types of feasibility study. They are operational, technical, and financial.

Operational Feasibility:

Proposed projects are beneficial only if they can be turned into information systems that will meet the organization's operating requirements. Issues that appear to be relatively minor in beginning have ways growing into major problems after implementation.

Technical Feasibility:

The technical issues usually raised during the feasibility stage of the investigation include these. Does the necessary technology exist to do what is suggested. Does the proposed equipment have the technical capacity to hold the date required using the new system? Can the system be expanded? If developed?

Financial Feasibility:

A system can be developed technically and that will be used if installed must still be a good investment for the organization financial benefits must equal or exceed the costs. The cost to conduct a full system investigation and the cost of h/w and s/w are considered. All the above three feasibility studies are conducted and the proposed systems are found to be feasible.

Proposed system:

In order to make the process easier, faster and any concerned authorities to access any particular information, a newly designed system could resolve the problems and derives certain benefits to the concern. The following merits are obtained from the proposed system,

1. The processes are done easily.
2. It provides the user-friendly interface.
3. The effective management is possible.
4. Time saving.
5. Reduce the errors and gives correct results.
6. Improves security by providing different access level.

SYSTEM SPECIFICATION

Hardware Specification

Processor	:	Celeron or Pentium III
Hard disk Capacity	:	10.2 GB
Display	:	VGA
RAM	:	64 MB
Color Monitor	:	15inches

Software Specification

Operating System	:	Windows NT
Web Server	:	IIS 4.0
Front End Tools	:	ASP, HTML Front Page
Back End Tool	:	MS-Access or SQLServer 7.0 or Oracle

Windows NT Server is More Secure:

Because IIS uses NTFS security when it's run under Windows NT Server4.0, Windows NT Server is a more secure platform for hosting ASP applications. Because Window 98 and Window 95 use MS-PWS, a watered-down version of IIS, you can't implement security permissions unless you use Windows NT.

SYSTEM DESIGN

Software Design Fundamentals:

Design is the first step in the development phase for any product. It is the process of applying various techniques and principles for the purpose of defining a device, a realization. The inputs to design phase are software requirements specification, DFDs, CFDs, E-R diagrams, Warnier diagrams and Structure Diagrams depending on the analysis methods we use and output will be Design Specification applicable to all software design.

The importance of Design:

As soon as the requirement analysis and requirements specification is over, the technical activities – design, code and test follow. In this list, design is highly complex. Design forms the basis of implementation, testing and maintenance. Without design, we have the risk of building a non stable system, which may affect implementation changes, test efficiency, and quality of the system.

Design Types:

Here preliminary design takes requirements and transforms them into architectural representation. Detailed design takes architectural representation and refines them that lead to detailed data structure and algorithmic representations.

Apart from data, architectural, and procedural design, Interface design designs layout of human-machine interaction.

Input Design:

An inaccurate input data is one of the most common causes of errors in data processing. Errors committed by data entry operators can be controlled by input design. The following features have been incorporated into the input designs of the proposed system.

1. Easy Input Design:

Data entry screen has been designed which are similar in format to the source document. An input design prompts the user in entering the right data in an appropriate text box.

2. Data Validation:

The input data are validated to minimize the errors in data entry. For certain data specifications, codes have been given and validation is done which doesn't enable the user to enter wrong code.

3. Output Design:

For many users, output is the main reason for opting a new system and is the basis on which they evaluate the usefulness of the system. Once the output requirements are determined, the system and how to structure it so that the required output can be produced.

4. Fundamentals of Software Design:

The objective of design is to get the program right, other than getting it work. The following concepts must be considered while designing any software.

5. Levels of Abstraction:

In modular design, the levels of abstraction method are used. In the highest level, the solution is stated and in each lower level, solution step is elaborated. At the lowest level, solution is stated in the manner that can be directly implemented. Human use abstraction to deal with complexity.

Stepwise Refinement:

Nicholas Wirth proposed this top down methodology. The architecture of program is developed by successively refining levels of procedural detail. Decomposing a procedural abstraction in a stepwise fashion until programming language statements are reached develops a hierarchy. Refinement is actually a process of elaboration.

Modularity:

Software is divided into different modules that are integrated. Since the monolithic software is difficult to grasp, we need to decompose them into modules. But care should be taken when modularizing. Because at one point of time, recursive modularizing will increase the total effort.

Modular Design:

Modules may be categorized as sequential (referenced and executed without apparent interruption by the application s/w), incremental (interrupted by application s/w and continued) and parallel module. Each module must be unique in operation. This concept is called Functional Independences.

Data Design:

The primary activity during data design is to select logical representations of data objects identified during the requirement definition and specifically phase. They identify those program modules that must operate directly upon the logical data structures.

Architectural Design:

The primary objective of architectural design is to develop a modular program structure and to represent the control relationships between modules.

Procedural Design:

Procedural design occurs after data and program structure has been established. Procedures, also, need to be unambiguous. For procedural design, the following concepts are taken into account.

- K Structured programming
- K Graphical representation <flow Charts>
- K Using constructs of looping & nesting
- K Box diagram for representing constructs.

Entities:

System: Service Information System

For the proposed software system, it is necessary that the output report to be compatible in format with the existing system. The output has been designed with these requirements in mind.

SYSTEM IMPLEMENTATION

Introduction:

System implementation explains the input and output screens which are used in our software and also explains the purpose of input and output screens. It also gives an overall idea about our system.

INPUT SCREENS (Model)

1. Jobseekers Master:

Jobseekers Master is used for entering, editing and deleting the information delivered by the jobseekers. The details which are entered in this master are:

- | | |
|-------------------|---------------------|
| 1. Candidate Name | 5. Gender |
| 2. Address | 6. Qualification |
| 3. DOB | 7. Experience |
| 4. Mail_Id | 8. Area of interest |

2. Employee Master:

Employer Master is used for entering, editing and deleting the details about the company. The details are:

Company Name	URL
Contact Person Name	Mail-Id
Company Address	Job Title
Address Line 1	Number of Vacancies
Address Line 2	Phone No
Preferrable s/w area	

Java_cand:

According to candidate's area of interest and the result of their online exam in their area of interest (such as Java, ASP, JSP, EJB etc.) their info. are maintained in separate tables. Informations of selected candidates those who are interested in Java are stored in Java candidate table. Similarly, ASP, ORACLE, VB, C, C++, etc. preferable candidate's informations are stored in specified tables.

Source Code (Sample)

```
<html>
<meta name="Microsoft Theme" content="clouds 000, default">
body bgcolor="#FFFFFF" text="#000000" link="#993300"
  vlink="#666600" alink="#CC3300">

<form action="Details.htm" method=post form=compentry_form>
<% dim con,rs,sql
set con=Server.CreateObject("adodb.connection")
set rs=server.createobject("adodb.recordset")
sql="Select * from compentry where compid='" & Request.Form
("CompId") & "' and cpwd= '" & Request.Form("CPassword")
& "'"
con.open "projdsn"
rs.open sql,con
```



```
<font color=#000fff><b>Thuliindia.com</b></font>
<font color=#880000 size=4><b> then please,
<a href="Jobseekers.htm"><font color=#880000 size=4><b>
try it again.</b></font></a></p><br>
<p align=center>
</p><br>

<%end if%>
</body>
</html>

<html>

<head>
<meta http-equiv="Content-Type" content="text/html; charset=windows-1252">
<meta http-equiv="Content-Language" content="en-us">
<title>Thuli Home Page</title>
<meta name="GENERATOR" content="Microsoft FrontPage 4.0">
<meta name="ProgId" content="FrontPage.Editor.Document">
<meta name="Microsoft Theme" content="clouds 111, default">
<meta name="Microsoft Border" content="tlrb">
</head>

<body bgcolor="#ffcccc" text="#000000" link="#666600" vlink="#993300"
alink="#CC3300"><!--msnavigation--><table border="0" cellpadding="0"
cellspacing="0" width="100%"><tr><td>

<p align="center"><font size="6"><strong></strong></font><br>
</p>
<p align=center>&nbsp;&nbsp;&nbsp;&nbsp;&nbsp;&nbsp;
<p align=center><br><font color=#000fff
size=5><b>ThuliIndia Welcomes You</b></font></p>
<table border=0 ><tr><td><font color=#880000 size=3><b>THULI is a Global
Career Consulting Company which has a database of professionals from the IT
Industry.

Besides it also has a wide network of Local,National and Internatioal Software Companies and
Groups.Thuli helps the candidates to find the best jobs in the Industry and also identifies the right talent
for the Software Companies. It basically connects the demand and requirement aspects.<b></font>
```

```

</td></tr></table>
</td></tr><!--msnavigation--></table><!--msnavigation--><table border="0"
cellpadding="0" cellspacing="0" width="100%"><tr><td valign="top" width="1%">

</td><td valign="top" width="24"></td><!--msnavigation--><td valign="top"><!--
msnavigation--></td><td valign="top" width="24"></td><td valign="top"
width="1%">

<p>&nbsp;</p>

</td></tr><!--msnavigation--></table><!--msnavigation--><table border="0"
cellpadding="0" cellspacing="0" width="100%"><tr><td>
<p align="center">
&nbsp;&nbsp;&nbsp;<script language="JavaScript"><!--
MSFPHover =
    ((navigator.appName == "Netscape") &&
    (parseInt(navigator.appVersion) >= 3 )) ||
    ((navigator.appName == "Microsoft Internet Explorer") &&
    (parseInt(navigator.appVersion) >= 4 ));
function MSFPpreload(img)
{
    var a=new Image(); a.src=img; return a;
}
// --></script><script language="JavaScript"><!--
if(MSFPHover) {
MSFPnavln=MSFPpreload("_derived/Main.htm_cmp_clouds110_hbtn.gif");
MSFPnavlh=MSFPpreload("_derived/Main.htm_cmp_clouds110_hbtn_a.gif"); }
// --></script><a href="Main.htm" language="JavaScript"
onmouseover="if(MSFPHover) document['MSFPnav1'].src=MSFPnavlh.src"
onmouseout="if(MSFPHover) document['MSFPnav1'].src=MSFPnavln.src"></a>
</p>
<p align="center">
&nbsp;&nbsp;&nbsp;</p>
</td></tr><!--msnavigation--></table></body></html>

<html>

<head>
<meta http-equiv="Content-Type" content="text/html; charset=windows-1252">

```

```
<title>Main</title>
<meta name="GENERATOR" content="Microsoft FrontPage 4.0">
<meta name="ProgId" content="FrontPage.Editor.Document">
<meta name="Microsoft Theme" content="clouds 111, default">
<meta name="Microsoft Border" content="trb, default">
</head>

<body bgcolor="#fcffcc" text="#000000" link="#666600" vlink="#993300"
alink="#CC3300"><!--msnavigation--><table border="0" cellpadding="0"
cellspacing="0" width="100%"><tr><td>

<p align="center"><font size="6"><strong></strong></font><br>
</p>
<p align=left></p>
<p align="center">&nbsp;</p>

</td></tr><!--msnavigation--></table><!--msnavigation--><table border="0"
cellpadding="0" cellspacing="0" width="100%"><tr><!--msnavigation--><td
valign="top"><TABLE border=0 cellPadding=0 cellSpacing=0 width="100%">
  <TBODY>
    <TR>
      <TD align=right bgColor=#666666 height=20 vAlign=top width=20>
        <p align="center">&nbsp;<IMG border=0 src="rightarrow.gif" width="20"
height="20"></p>
      </TD>
      <TD align=right bgColor=#666666 height=20 vAlign=center>
        <p align="center"><FONT color=#ffffff
        face=Arial size=1>&nbsp;</FONT><B> <font color="#ffffff" face="Arial"
size="2"> - Welcome!</font></B></p>
      </TD>
      <TD align=right bgColor=#666666 height=20 vAlign=top>
        <p align="center"><IMG border=0
        src="keyboard.gif" align="right" width="249" height="56"></p>
      </TD></TR>
    </TBODY></TABLE><TABLE border=0 cellPadding=0 cellSpacing=0 width="100%">
  <TBODY>
    <TR>
      <TD valign=top><TABLE border=0 height=363 width="100%">
        <TBODY>
          <TR><!-- Start Left Nav -->
            <TD bgColor=#767d99 vAlign=top width=220>
```



```
<p align="center">
&nbsp;&nbsp;&nbsp;<script language="JavaScript"><!--
MSFPHover =
  ((navigator.appName == "Netscape") &&
  (parseInt(navigator.appVersion) >= 3 )) ||
  ((navigator.appName == "Microsoft Internet Explorer") &&
  (parseInt(navigator.appVersion) >= 4 ));
function MSFPpreload(img)
{
  var a=new Image(); a.src=img; return a;
}
// --></script><script language="JavaScript"><!--
if(MSFPHover) {
MSFPnav1n=MSFPpreload("_derived/JobSeekers.htm_cmp_clouds110_hbtn.gif");
MSFPnav1h=MSFPpreload("_derived/JobSeekers.htm_cmp_clouds110_hbtn_a.gif"); }
// --></script><a href="JobSeekers.htm" language="JavaScript"
onmouseover="if(MSFPHover) document['MSFPnav1'].src=MSFPnav1h.src"
onmouseout="if(MSFPHover) document['MSFPnav1'].src=MSFPnav1n.src"></a> <script
language="JavaScript"><!--
if(MSFPHover) {
MSFPnav2n=MSFPpreload("_derived/Employers.htm_cmp_clouds110_hbtn.gif");
MSFPnav2h=MSFPpreload("_derived/Employers.htm_cmp_clouds110_hbtn_a.gif"); }
// --></script><a href="Employers.htm" language="JavaScript"
onmouseover="if(MSFPHover) document['MSFPnav2'].src=MSFPnav2h.src"
onmouseout="if(MSFPHover) document['MSFPnav2'].src=MSFPnav2n.src"></a> <script
language="JavaScript"><!--
if(MSFPHover) {
MSFPnav3n=MSFPpreload("_derived/WebAdmin.htm_cmp_clouds110_hbtn.gif");
MSFPnav3h=MSFPpreload("_derived/WebAdmin.htm_cmp_clouds110_hbtn_a.gif"); }
// --></script><a href="WebAdmin.htm" language="JavaScript"
onmouseover="if(MSFPHover) document['MSFPnav3'].src=MSFPnav3h.src"
onmouseout="if(MSFPHover) document['MSFPnav3'].src=MSFPnav3n.src"></a>
</p>
<p align="center">
&nbsp;&nbsp;&nbsp;<script language="JavaScript"><!--
if(MSFPHover) { MSFPnav4n=MSFPpreload("_derived/home_cmp_clouds110_home.gif");
MSFPnav4h=MSFPpreload("_derived/home_cmp_clouds110_home_a.gif"); }
```



```
// --></script><a href="Index.htm" language="JavaScript"
onmouseover="if(MSFPPhover) document['MSFPnav4'].src=MSFPnav4h.src"
onmouseout="if(MSFPPhover) document['MSFPnav4'].src=MSFPnav4n.src"></a>
</p>
</td></tr><!--msnavigation--></table></body>

</html>
```

.....

```
<html>
<head>
<meta http-equiv="Content-Type" content="text/html; charset=windows-1252">
<title>JobSeekers</title>

<META HTTP-EQUIV="Content-Type" CONTENT="text/html; charset=windows-1252">
<META HTTP-EQUIV="Content-Language" CONTENT="en-us">
</HEAD>
<BODY>
<body background="_themes/clouds/clouds.jpg" bgcolor="#0000FF" text="#000000"
link="#666600" vlink="#993300" alink="#CC3300"><!--msnavigation--><table
border="0" cellpadding="0" cellspacing="0" width="100%"><tr><td>

<p align="center"><font size="6"><strong></strong></font><br>
</p>
<p align="center">&nbsp;</p>

</td></tr><!--msnavigation--></table><!--msnavigation--><table border="0"
cellpadding="0" cellspacing="0" width="100%"><tr><!--msnavigation--><td
valign="top"><p>&nbsp;<p><font size="3" color="#800000"><b>Thuli registers
jobseekers by...</b></font>
<!--msthemelist--><table border="0" cellpadding="0" cellspacing="0"
width="100%">
  <!--msthemelist--><tr><td valign="baseline" width="42"></td><td
valign="top" width="100%"><font color="#800000" size="3"><b>Accepting their
resumes through Registration.</b></font><!--msthemelist--></td></tr>
```



```

Account</font></A><FONT face=arial size="2">
</FONT></font><FONT
color=#800080 face=arial size="2"> to get started.

You'll need to register to use our online services.&nbsp;  </FONT></b></p>
<!--msnavigation--><table border="0" cellpadding="0" cellspacing="0"
width="100%"><tr><td>

<!--webbot BOT="GeneratedScript" PREVIEW=" " startspan --><script
Language="JavaScript"><!--
function FrontPage_Form1_Validator(theForm)
{

    if (theForm.JobSeekId.value == "")
    {
        alert("Please enter a value for the \"JobSeekId\" field.");
        theForm.JobSeekId.focus();
        return (false);
    }

    if (theForm.JobSeekId.value.length < 5)
    {
        alert("Please enter at least 5 characters in the \"JobSeekId\" field.");
        theForm.JobSeekId.focus();
        return (false);
    }

    if (theForm.JobSeekId.value.length > 8)
    {
        alert("Please enter at most 8 characters in the \"JobSeekId\" field.");
        theForm.JobSeekId.focus();
        return (false);
    }

    var checkOK =
"ABCDEFGHIJKLMNPOQRSTUVWXYZabcdefghijklmnopqrstuvwxyzŠČŽšœžŸĂĂĂĂĂĂ#ÇÈÉÊËÌÍÎÏÐ
ÑÒÓÔÕÖØÙÚÛÜÝÞßàáâãääåæçèéêëìíîïðñóôõöøùúûýþÿ0123456789-";
    var checkStr = theForm.JobSeekId.value;
    var allValid = true;
    for (i = 0; i < checkStr.length; i++)
    {
        ch = checkStr.charAt(i);

```

```
    for (j = 0; j < checkOK.length; j++)
        if (ch == checkOK.charAt(j))
            break;
    if (j == checkOK.length)
    {
        allValid = false;
        break;
    }
}
if (!allValid)
{
    alert("Please enter only letter and digit characters in the \"JobSeekId\"
field.");
    theForm.JobSeekId.focus();
    return (false);
}

if (theForm.JPassword.value == "")
{
    alert("Please enter a value for the \"JPassword\" field.");
    theForm.JPassword.focus();
    return (false);
}

if (theForm.JPassword.value.length < 5)
{
    alert("Please enter at least 5 characters in the \"JPassword\" field.");
    theForm.JPassword.focus();
    return (false);
}

if (theForm.JPassword.value.length > 8)
{
    alert("Please enter at most 8 characters in the \"JPassword\" field.");
    theForm.JPassword.focus();
    return (false);
}

var checkOK =
"ABCDEFGHIJKLMNOPQRSTUVWXYZabcdefghijklmnopqrstuvwxyzŠĎŽšœžŸĂĂĂĂĂĂÇÈÈÈÈÈÈÏÏÏÏ
ÑÒÓÔÕÖØÙÚÛÜÝÞßàáâãääåæçèéêëìíîïðñòóôõöøùúûüýþÿ0123456789-";
var checkStr = theForm.JPassword.value;
var allValid = true;
```

```
for (i = 0; i < checkStr.length; i++)
{
    ch = checkStr.charAt(i);
    for (j = 0; j < checkOK.length; j++)
        if (ch == checkOK.charAt(j))
            break;
    if (j == checkOK.length)
    {
        allValid = false;
        break;
    }
}
if (!allValid)
{
    alert("Please enter only letter and digit characters in the \"JPassword\"
field.");
    theForm.JPassword.focus();
    return (false);
}
return (true);
}
//--></script><!--webbot BOT="GeneratedScript" endspan --><FORM METHOD="POST"
ACTION="jsentry.asp" onsubmit="return FrontPage_Form1_Validator(this)"
name="FrontPage_Form1" webbot-action="--WEBBOT-SELF--" WEBBOT-onSubmit="return
FrontPage_Form1_Validator(this)">
<!--webbot bot="SaveResults" U-File="formrslt.htm" S-Format="HTML/DL"
B-Label-Fields="TRUE" startspan --><input TYPE="hidden" NAME="VTI-GROUP"
VALUE="0"><!--webbot bot="SaveResults" endspan i-checksum="43374" -->
<p align=center><table height="39" width="306">
<tr>
<td bgColor="#000066" height="39" width="305"><b><font color="#ffffff"
face="Arial" size="2">&nbsp;&nbsp;&nbsp;JobSeeker
Login Information:</font></b></td>
</tr>
</table>
<TABLE width="305" height="95" bgcolor=#f0f0f0>
<TR >
<TD ALIGN="left" width="95" height="40">
<font color=#880000><b>JobSeeker_ID:</b></font></TD>
<TD width="95" height="40">
<!--webbot bot="Validation" S-Data-Type="String" B-Allow-Letters="TRUE"
B-Allow-Digits="TRUE" B-Value-Required="TRUE" I-Minimum-Length="5"
```



```

        ((navigator.appName == "Microsoft Internet Explorer") &&
        (parseInt(navigator.appVersion) >= 4 ));
function MSFPpreload(img)
{
    var a=new Image(); a.src=img; return a;
}
// --></script>
</p>
<p align="center">
<script language="JavaScript"><!--
if(MSFPhover) { MSFPnav2n=MSFPpreload("_derived/home_cmp_clouds110_home.gif");
MSFPnav2h=MSFPpreload("_derived/home_cmp_clouds110_home_a.gif"); }
// --></script><a href="Index.htm" language="JavaScript"
onmouseover="if(MSFPhover) document['MSFPnav2'].src=MSFPnav2h.src"
onmouseout="if(MSFPhover) document['MSFPnav2'].src=MSFPnav2n.src"></a> <script
language="JavaScript"><!--
if(MSFPhover) { MSFPnav3n=MSFPpreload("_derived/up_cmp_clouds110_up.gif");
MSFPnav3h=MSFPpreload("_derived/up_cmp_clouds110_up_a.gif"); }
// --></script><a href="Main.htm" language="JavaScript"
onmouseover="if(MSFPhover) document['MSFPnav3'].src=MSFPnav3h.src"
onmouseout="if(MSFPhover) document['MSFPnav3'].src=MSFPnav3n.src"></a> <script language="JavaScript"><!--
-
if(MSFPhover) { MSFPnav4n=MSFPpreload("_derived/next_cmp_clouds110_next.gif");
MSFPnav4h=MSFPpreload("_derived/next_cmp_clouds110_next_a.gif"); }
// --></script><a href="Employers.htm" language="JavaScript"
onmouseover="if(MSFPhover) document['MSFPnav4'].src=MSFPnav4h.src"
onmouseout="if(MSFPhover) document['MSFPnav4'].src=MSFPnav4n.src"></a>
</p>
</td></tr><!--msnavigation--></table></body>

</html>

<HTML>
<HEAD>
<META HTTP-EQUIV="Content-Type" CONTENT="text/html; charset=windows-1252">
<META HTTP-EQUIV="Content-Language" CONTENT="en-us">

```

```

<TITLE>New Page 1</TITLE>
</HEAD>
<BODY>
<body background="_themes/clouds/clouds.jpg" bgcolor="#0000FF" text="#000000"
link="#666600" vlink="#993300" alink="#CC3300"><!--msnavigation--><table
border="0" cellpadding="0" cellspacing="0" width="100%"><tr><td>

<p align="center"><font size="6"><strong></strong></font><br>
</p>

<!--webbot BOT="GeneratedScript" PREVIEW=" " startspan --><script
Language="JavaScript"><!--
function FrontPage_Form1_Validator(theForm)
{

    if (theForm.UserName.value == "")
    {
        alert("Please enter a value for the \"UserName\" field.");
        theForm.UserName.focus();
        return (false);
    }

    if (theForm.UserName.value.length < 5)
    {
        alert("Please enter at least 5 characters in the \"UserName\" field.");
        theForm.UserName.focus();
        return (false);
    }

    if (theForm.UserName.value.length > 8)
    {
        alert("Please enter at most 8 characters in the \"UserName\" field.");
        theForm.UserName.focus();
        return (false);
    }

    var checkOK =
"ABCDEFGHIJKLMNOPQRSTUVWXYZabcdefghijklmnopqrstuvwxyzŠčŽšœžŸĂĂĂĂĂĂÇÈÉÊËÌÍÎÏÐ
ÑÒÓÔÕÖØÙÚÛÜÝÞßàáâãäåæçèéêëìíîïðñóôõöøùúûüýþÿ0123456789-";
    var checkStr = theForm.UserName.value;
    var allValid = true;

```



```
for (i = 0; i < checkStr.length; i++)
{
    ch = checkStr.charAt(i);
    for (j = 0; j < checkOK.length; j++)
        if (ch == checkOK.charAt(j))
            break;
    if (j == checkOK.length)
    {
        allValid = false;
        break;
    }
}
if (!allValid)
{
    alert("Please enter only letter and digit characters in the \"UserName\"
field.");
    theForm.UserName.focus();
    return (false);
}

if (theForm.Password.value == "")
{
    alert("Please enter a value for the \"Password\" field.");
    theForm.Password.focus();
    return (false);
}

if (theForm.Password.value.length < 5)
{
    alert("Please enter at least 5 characters in the \"Password\" field.");
    theForm.Password.focus();
    return (false);
}

if (theForm.Password.value.length > 8)
{
    alert("Please enter at most 8 characters in the \"Password\" field.");
    theForm.Password.focus();
    return (false);
}
```



```
if(MSFPPhover) { MSFPnav2n=MSFPpreload("_derived/back_cmp_clouds110_back.gif");
MSFPnav2h=MSFPpreload("_derived/back_cmp_clouds110_back_a.gif"); }
// --></script><a href="Employers.htm" language="JavaScript"
onmouseover="if(MSFPPhover) document['MSFPnav2'].src=MSFPnav2h.src"
onmouseout="if(MSFPPhover) document['MSFPnav2'].src=MSFPnav2n.src"></a> <script
language="JavaScript"><!--
if(MSFPPhover) { MSFPnav3n=MSFPpreload("_derived/home_cmp_clouds110_home.gif");
MSFPnav3h=MSFPpreload("_derived/home_cmp_clouds110_home_a.gif"); }
// --></script><a href="Index.htm" language="JavaScript"
onmouseover="if(MSFPPhover) document['MSFPnav3'].src=MSFPnav3h.src"
onmouseout="if(MSFPPhover) document['MSFPnav3'].src=MSFPnav3n.src"></a> <script
language="JavaScript"><!--
if(MSFPPhover) { MSFPnav4n=MSFPpreload("_derived/up_cmp_clouds110_up.gif");
MSFPnav4h=MSFPpreload("_derived/up_cmp_clouds110_up_a.gif"); }
// --></script><a href="Main.htm" language="JavaScript"
onmouseover="if(MSFPPhover) document['MSFPnav4'].src=MSFPnav4h.src"
onmouseout="if(MSFPPhover) document['MSFPnav4'].src=MSFPnav4n.src"></a>
</p>
</td></tr><!--msnavigation--></table>

<html>

<head>
<meta http-equiv="Content-Type" content="text/html; charset=windows-1252">
<title>New Page 3</title>
<meta name="GENERATOR" content="Microsoft FrontPage 4.0">
<meta name="ProgId" content="FrontPage.Editor.Document">
<meta name="Microsoft Theme" content="clouds 111, default">
<meta name="Microsoft Border" content="trb, default">
</head>

<body background="_themes/clouds/clouds.jpg" bgcolor="#0000FF" text="#000000"
link="#666600" vlink="#993300" alink="#CC3300"><!--msnavigation--><table
border="0" cellpadding="0" cellspacing="0" width="100%"><tr><td>
```



```
onmouseout="if(MSFPHover) document['MSFPnav2'].src=MSFPnav2n.src"></a>  
</p>  
</td></tr><!--msnavigation--></table></body>  
  
</html>  
<H5>Copyright © 2001 [Thuliindia]. All rights reserved. <BR>  
</H5>  
</BODY>  
</HTML>
```

Screen Design (Sample)



Registration		
Registration		
Namaste, Vanakkam, Hi..... Your thulliindia.com registers you through this form		
Personal Account Information <i>(Required)</i>		
The more we know about you, the more we can offer you. So, do tell us a little about yourself.		
Your Name	First Name UMA	Last Name DESIGAN
Gender	<input type="radio"/> Male	<input type="radio"/> Female
Marital Status	<input checked="" type="radio"/> Single	<input type="radio"/> Married
Date Of Birth	31/05/1978	
Nationality	INDIAN	
AddressLine1	M-31,STAGE-2,TNHB COLONY,	
AddressLine2	V.M.CHATHRAM,TIRUNELVELI.	
PinCode	620 011	
Phone	573149	
Mail_Id	umas_315@yahoo.com	

Qualification

Experience

We are collecting some information from you in this form. Given the long-term relations we are going to share, by understanding you better, we can customise our offerings for you.

Please click the area of your interest.

Java C

ASP C++

JSP Oracle

EJB Visual Basic

Java Beans Web Designing

Review and Submit:

By submitting your registration information, you indicate that you agree to the terms of use. The submission of this form will constitute your consent to the collection and use of this information.

Copyright © 2001 Thuliindia. All rights reserved.

Employers

If you're already registered at Thuliindia.com, log in now. If not, select Create New Account to get started. You'll need to register to use our online services.

Employer Login Information:

Employer_ID:

Password:

Create New Account

Copyright © 2001 ThuliIndia. All rights reserved.

New Employer Login Information

User Name

Password

Confirm Password

Copyright © 2001 [ThuliIndia]. All rights reserved.



Thuli registers candidates by ...

- * Accepting their resumes through Registration.
- * Candidates should attend the Online exam conducted by Thuli.
- * Selected candidates are given a Register number which he/she has to mention in correspondence.

Thuli recruits the candidates by ...

- * Registered candidate's resume as per their experience in their preferred software Language will be sent to the Concerned Company with regard to the

vacancies.

- * Candidates will be conveyed about the information regarding the submission of their resumes to the Company that is tied up with Thuli.
- * This will be to avoid the candidates communicating with Thuli.

If you're already registered at Thullindia.com, log in now. If not, select **Create New Account** to get started. You'll need to register to use our online services.

JobSeeker Login Information:

JobSeeker_ID:

Password:

Create New Account

Copyright © 2001 Thuliindia. All rights reserved.

WebMaster

Administrator Login Information:

User Name:

Password:

Copyright © 2001 Thuliindia. All rights reserved.

Employer Information

JOB CONTACT AND COMPANY INFORMATION

Company Name:	<input type="text" value="WIPRO"/>
Contact Person Name:	<input type="text" value="SAI"/>
Address Line 1:	<input type="text" value="23,BEACH ROAD,ANNASALAI"/>
Address Line 2:	<input type="text" value="CHENNAI-85"/>
Pin Code:	<input type="text" value="600 095"/>
Phone:	<input type="text" value="4499450"/>
No Of Vacancy:	<input type="text" value="5"/>
Experience	<input type="text" value="Below 3"/>
Job Title:	<input type="text" value="SOFTWARE DEVELOPMENT IN VB"/>
Email Address:	<input type="text" value="wip_sai@hotmail.com"/>
Company URL:	<input type="text" value="wipro.com"/>

◀ Back
■ Home
▲ Up
▶ Next

Copyright © 2001 ThuliIndia. All rights reserved.

Summary

Phase I

With all the above mentioned information develop a web site. Make use of the table, design, and screen as an example. You have the right to customize the system in your own but at the same time don't change main theme of the project.

Phase II

Extend the above system as a B2C. You can add to the above system with credit card validation for the registration of the employee and the employer.

❧